

#	Unit Name	Width	Height	Depth	L.SCR	R.SCR
1	Tall Panel 1LE	18	2500	100	0	0
2	Tall 2 Door	979	2500	510	0	0
3	Tall Panel 1LE	18	2500	530	0	0
4	Upper 2 Doors	982	632	510	0	0
5	Under Panel E 1L OS	982	18	510	0	0
6	Upper L Filler E 1L 1S	18	652	530	0	0

Rade-riviera st mentone

Default

Room #1 (Kitchen) - Wall #2

Date: 17/07/23

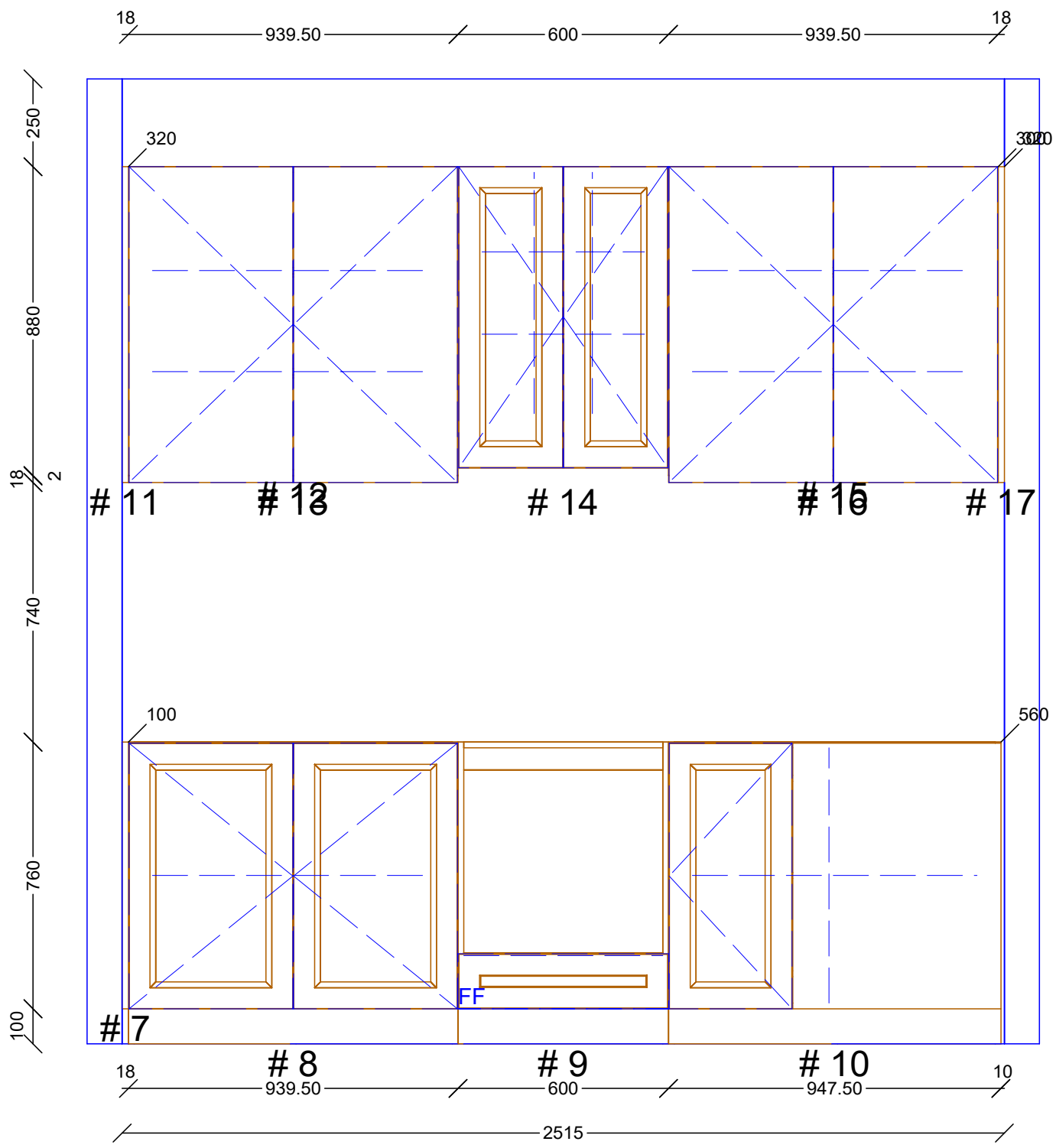

#	Unit Name	Width	Height	Depth	L.SCR	R.SCR
7	Base Panel E 1L OS	18	760	100	0	0
8	Base 2 Door	939.50	860	560	0	0
9	UBO 600mm	600	860	560	0	0
10	Base Blind R 1 Door	947.50	860	560	0	0
11	Upper Panel E 1L 2S	18	900	320	0	0
12	Upper 2 Doors	939.50	880	300	0	0
13	Under Panel E 1L OS	939.50	18	300	0	0
14	Rhood Chute AS	600	900	300	0	0

Rade-riviera st mentone

Default

Room #1 (Kitchen) - Wall #5

Date: 17/07/23

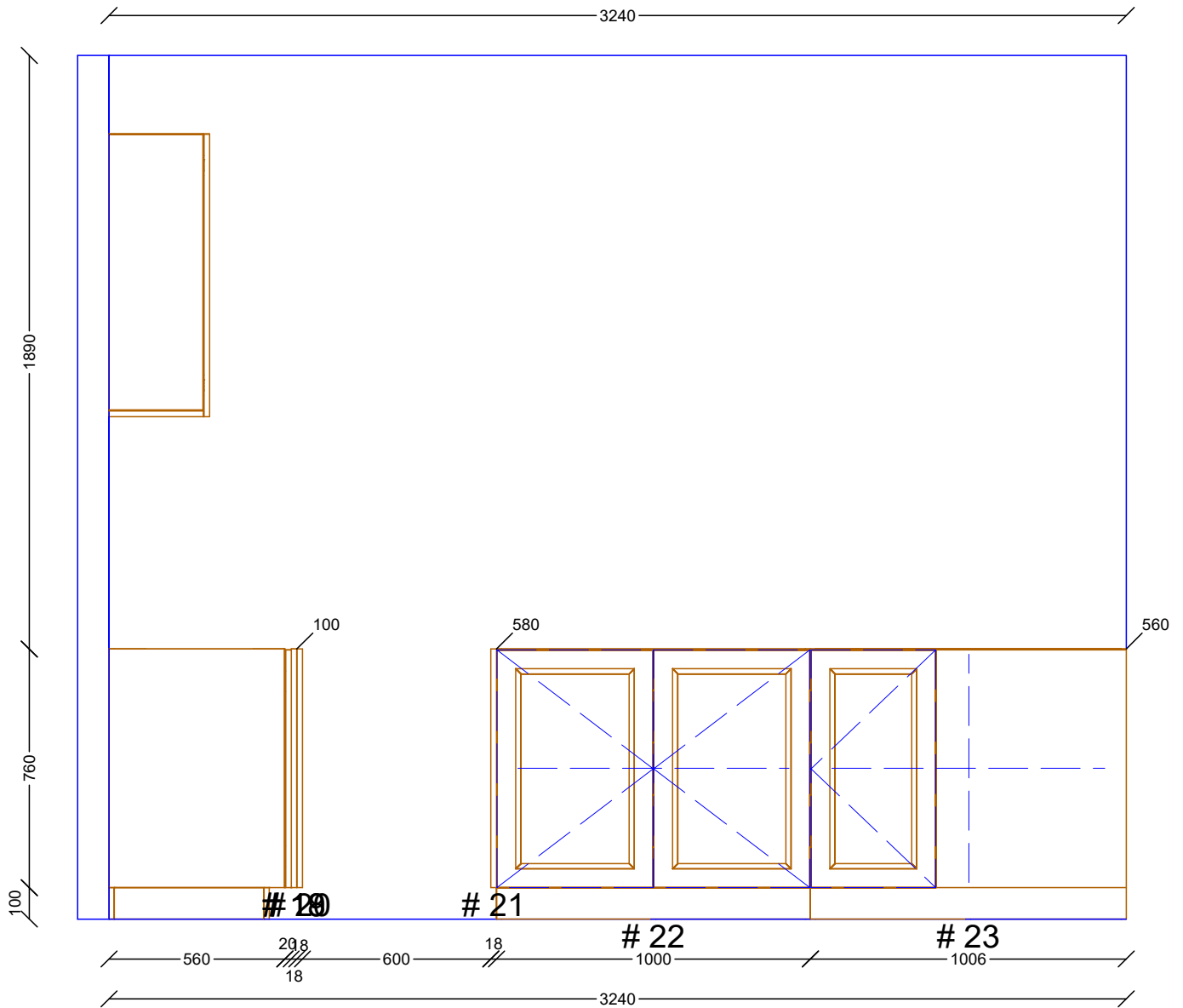

#	Unit Name	Width	Height	Depth	L.SCR	R.SCR	
18	Base Panel E 1L OS	18	760	100	0	0	Rade-riviera st mentone
19	Base Panel E 1L OS	18	760	100	0	0	
20	Base Panel E 1L OS	18	760	580	0	0	Default
21	Base Panel E 1L OS	18	760	580	0	0	Room #1 (Kitchen) - Wall #6
22	Base 2 Door Sink	1000	860	560	0	0	
23	Base Blind R 1 Door	1006	860	560	0	0	
							Date: 17/07/23

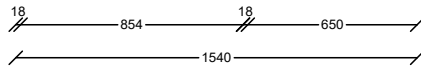
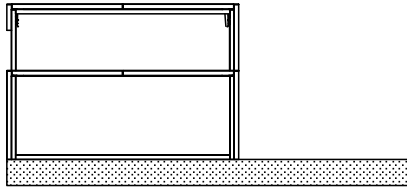
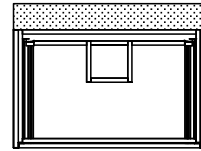
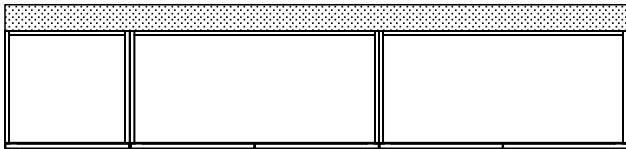
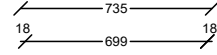
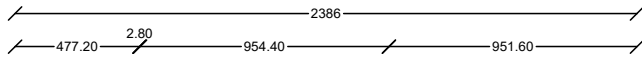

#	Unit Name	Width	Height	Depth	L.SCR	R.SCR
15	Upper 2 Doors	939.50	880	300	0	0
16	Under Panel E 1L 0S	939.50	18	300	0	0
17	Upper Panel E 1L 2S	18	900	320	0	0

Rade-riviera st mentone

Default

Room #1 (Kitchen) - Wall #5

Date: 17/07/23

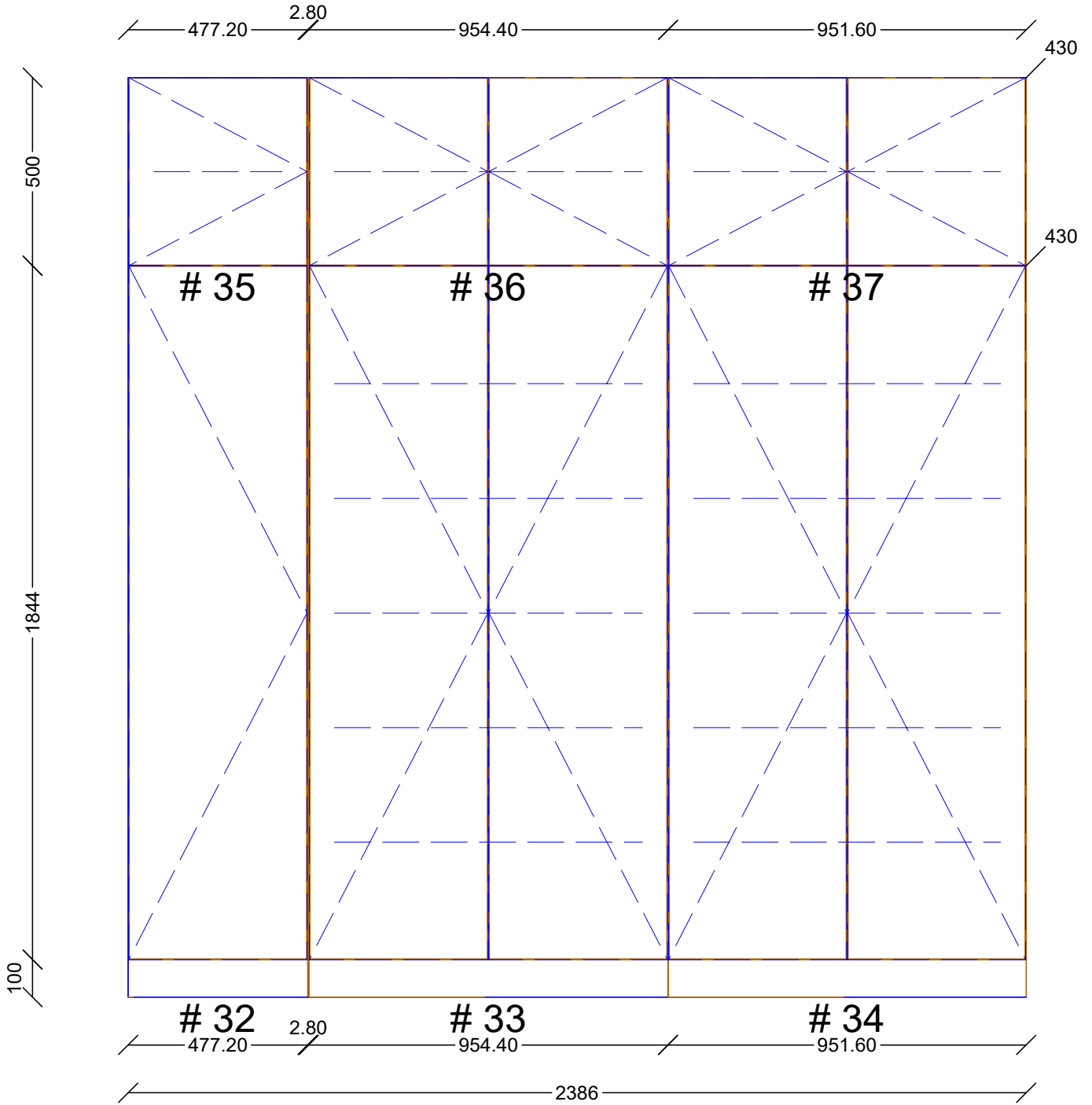

#	Unit Name	Width	Height	Depth	L.SCR	R.SCR
32	Tall 1 Door LH	477.20	1944	430	0	0
33	Tall 1 Door LH	954.40	1944	430	0	0
34	Tall 1 Door LH	951.60	1944	430	0	0
35	Upper 1 Door L	477.20	500	430	0	0
36	Upper 1 Door L	954.40	500	430	0	0
37	Upper 1 Door L	951.60	500	430	0	0

Rade-riviera st mentone

Default

Room #2 (Laundry) - Wall #1

Date: 17/07/23

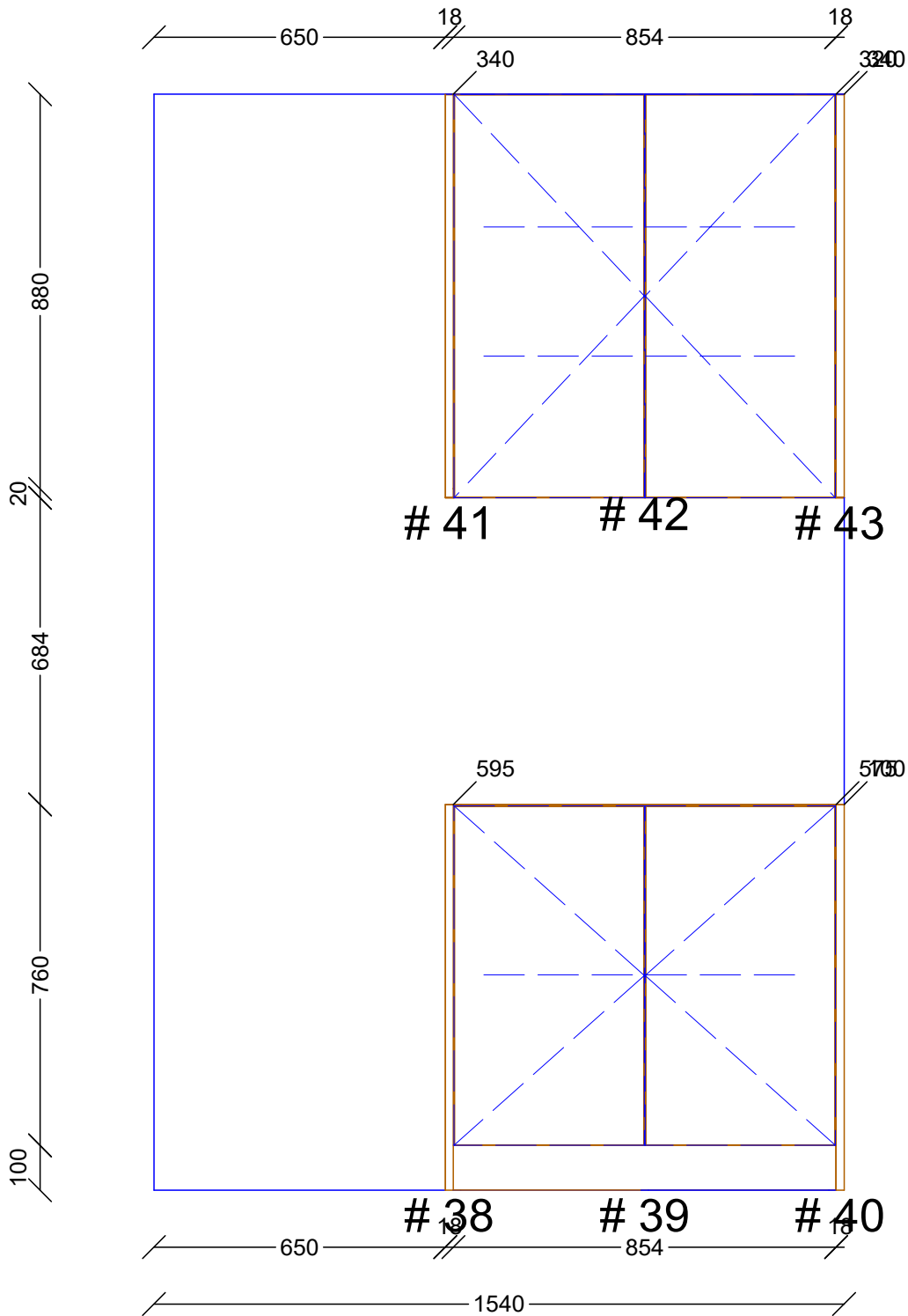

#	Unit Name	Width	Height	Depth	L.SCR	R.SCR
38	Base Panel E 1L 0S	18	860	595	0	0
39	Base 2 Door Sink	854	860	575	0	0
40	Base Panel E 1L 0S	18	860	100	0	0
41	Upper Panel E 1L 2S	18	900	340	0	0
42	Upper 2 Doors	854	880	320	0	0
43	Upper Panel E 1L 2S	18	900	340	0	0

Rade-riviera st mentone

Default

Room #2 (Laundry) - Wall #2

Date: 17/07/23

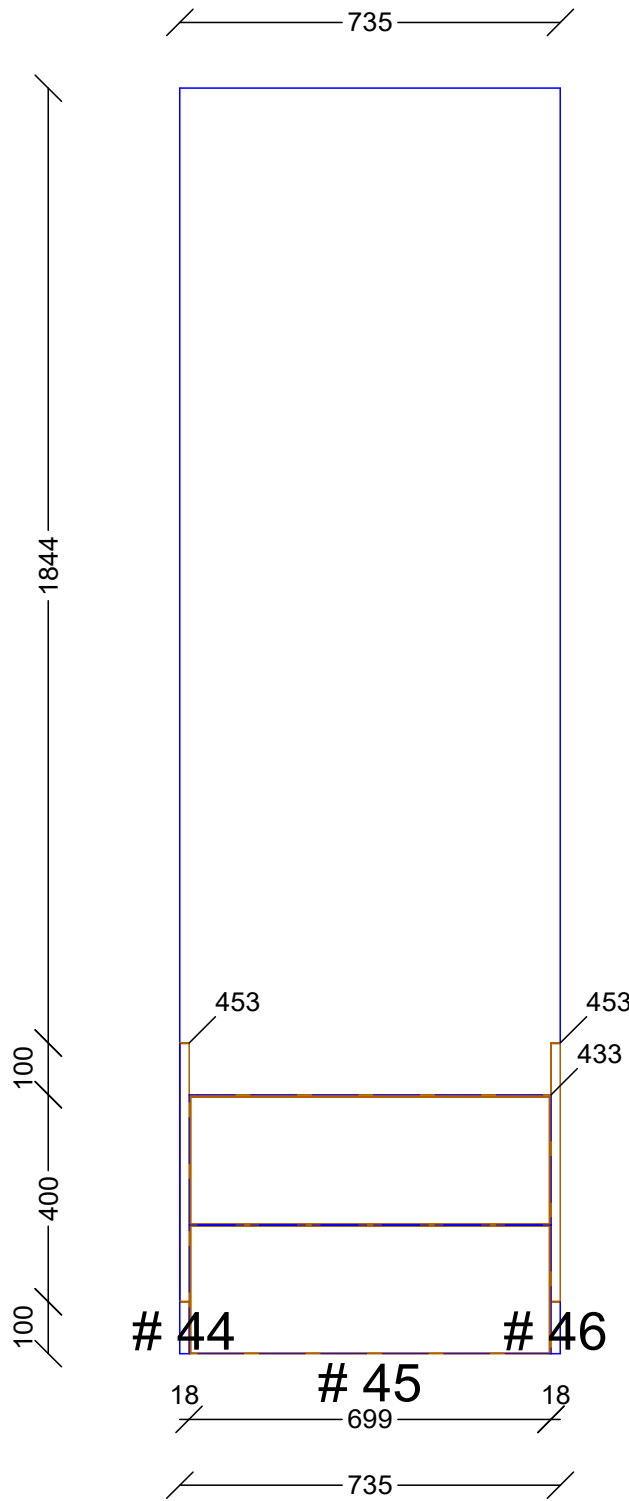

#	Unit Name	Width	Height	Depth	L.SCR	R.SCR	
44	Base Panel E 2L 2S	18	500	453	0	0	Rade-riviera st mentone
45	Base 4 Draw	699	500	433	0	0	Default
46	Base Panel E 2L 2S	18	500	453	0	0	
							Room #2 (Laundry) - Wall #3
							Date: 17/07/23