

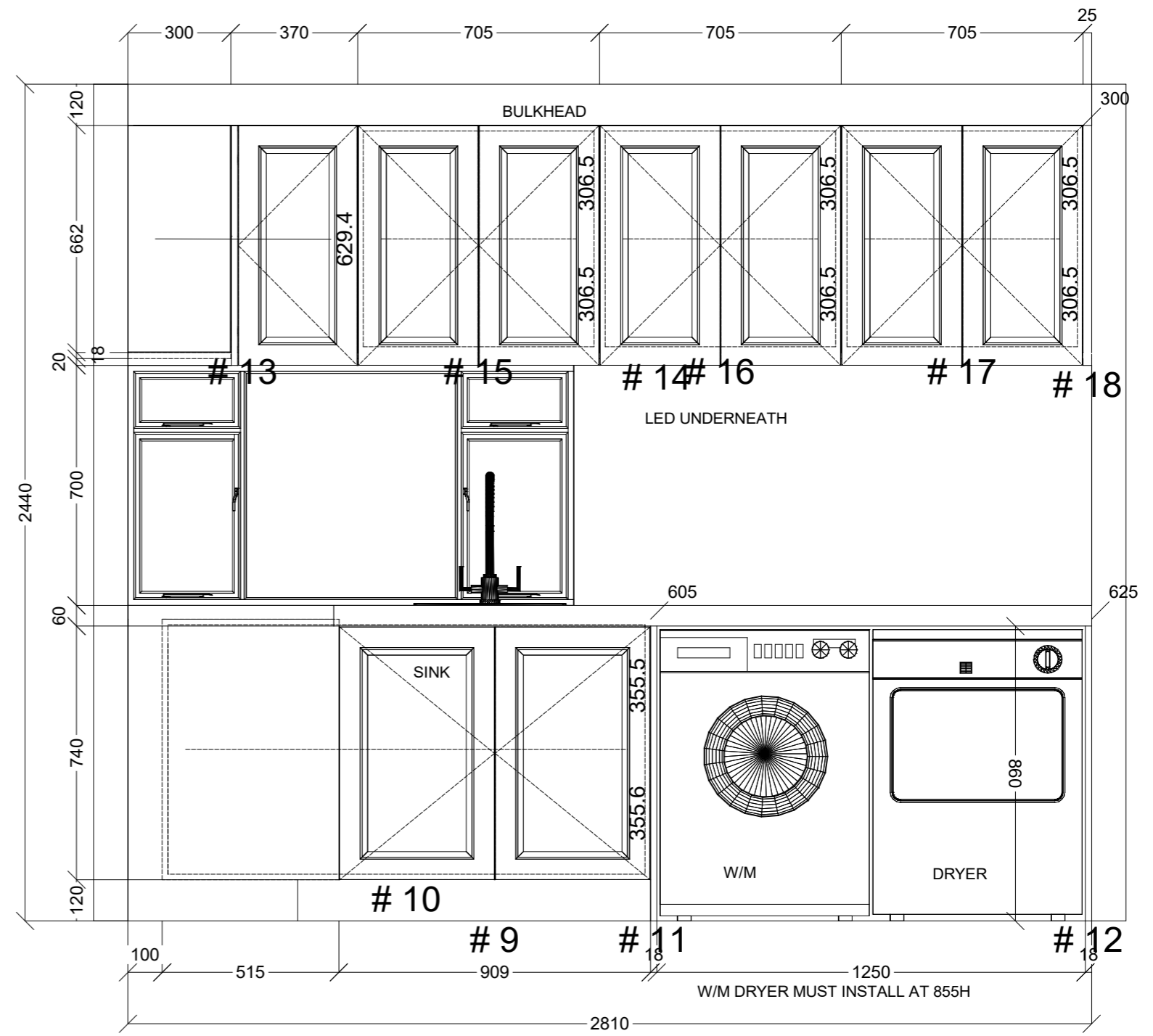

 CONNECT KITCHENS	Client: JAMES JACOBSON		Door and panels style/colour: 2PAC TBA SHAKER 45 BEVEL		Sheet 1 of 4
	Room: LAUNDRY	Benchtop Colour: 60MM MARBLE TBC		Drawer slides: BLUM ANTARO	Carcass: WHITE HMR
	Date: 27/09/23	Address: 91 BULLEEN RD NTH BALWYN		Handles Item No: BY CUSTOMER	Approved by:

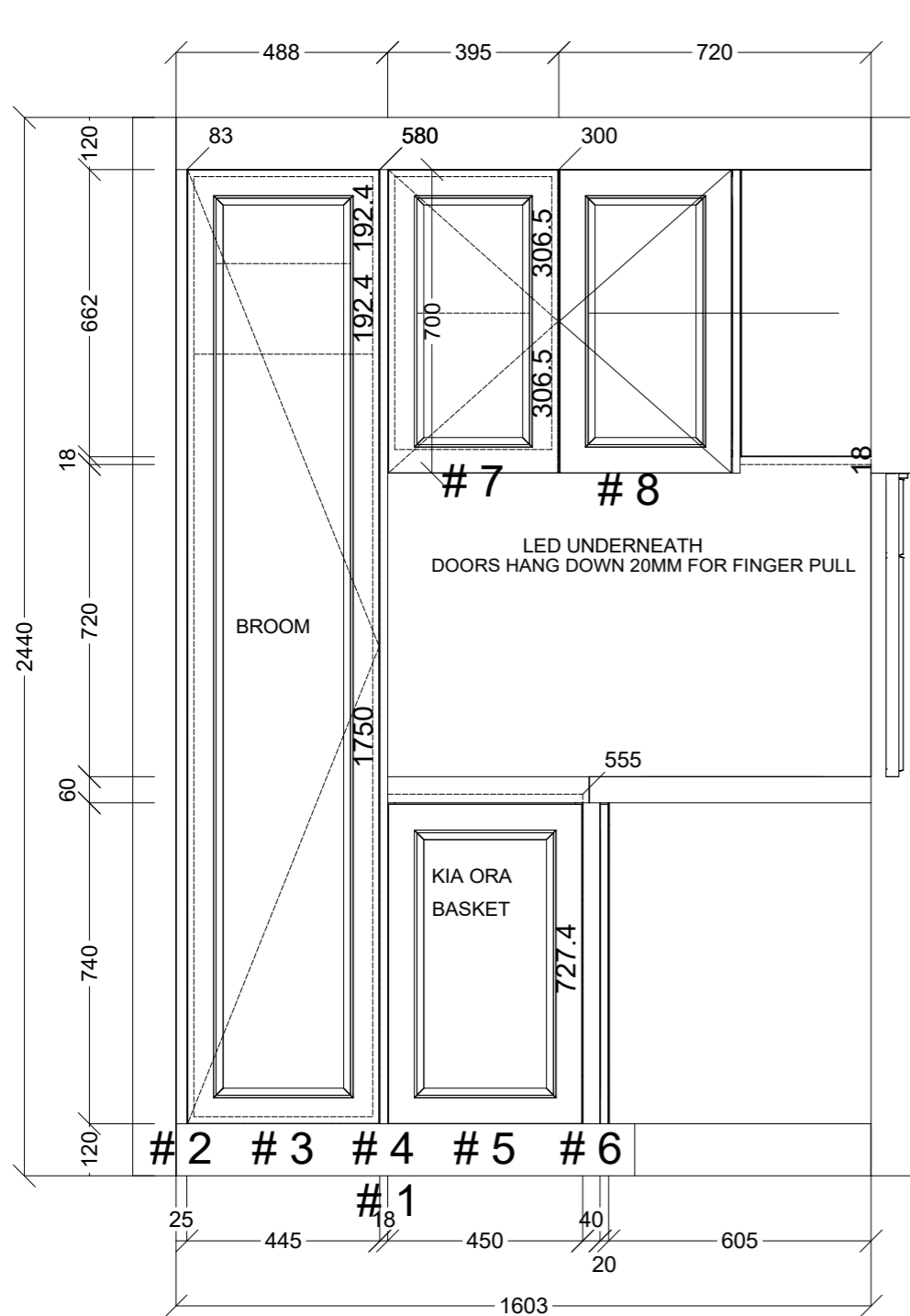

	Client: JAMES JACOBSON		Door and panels style/colour: 2PAC TBA SHAKER 45 BEVEL		Sheet 2 of 4
	Room: LAUNDRY	Benchtop Colour: 60MM MARBLE TBC		Drawer slides: BLUM ANTARO	Carcass: WHITE HMR
	Date: 27/09/23	Address: 91 BULLEEN RD NTH BALWYN		Handles Item No: BY CUSTOMER	Approved by:

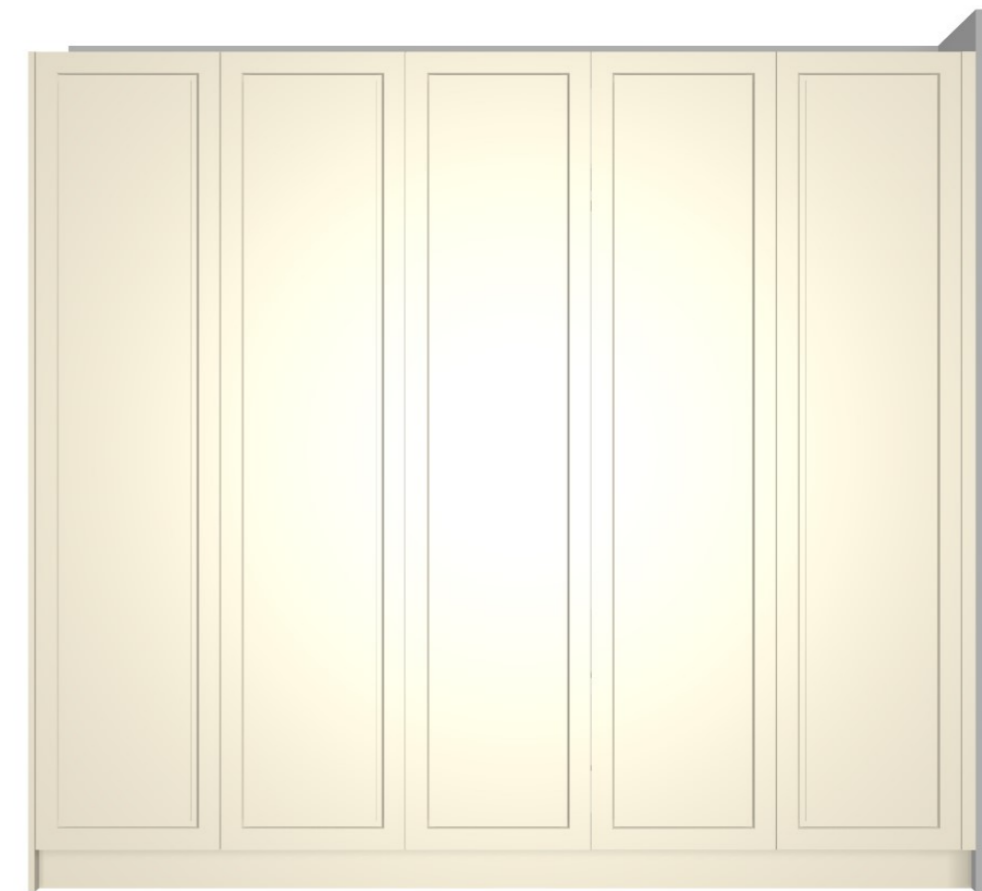
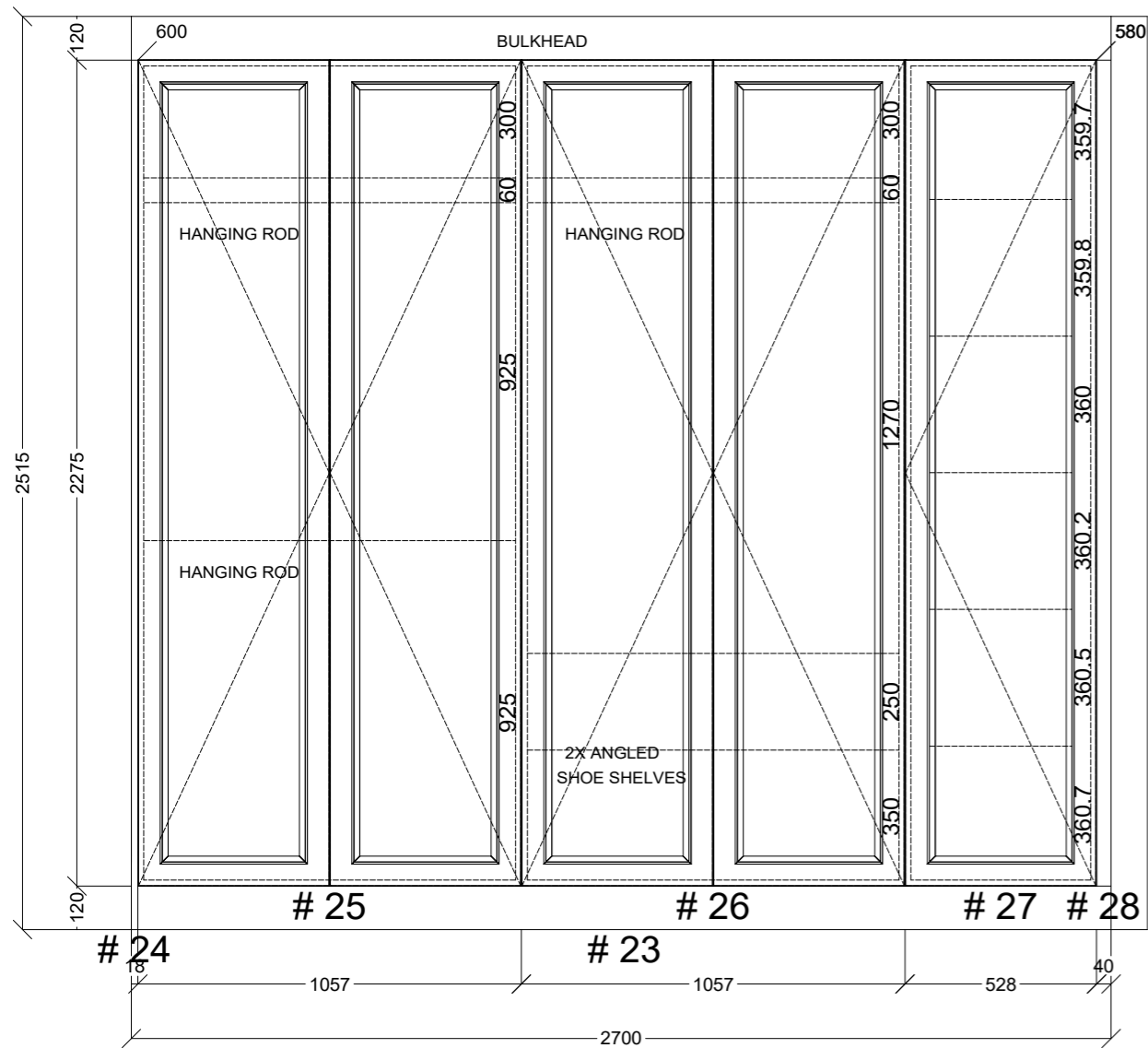
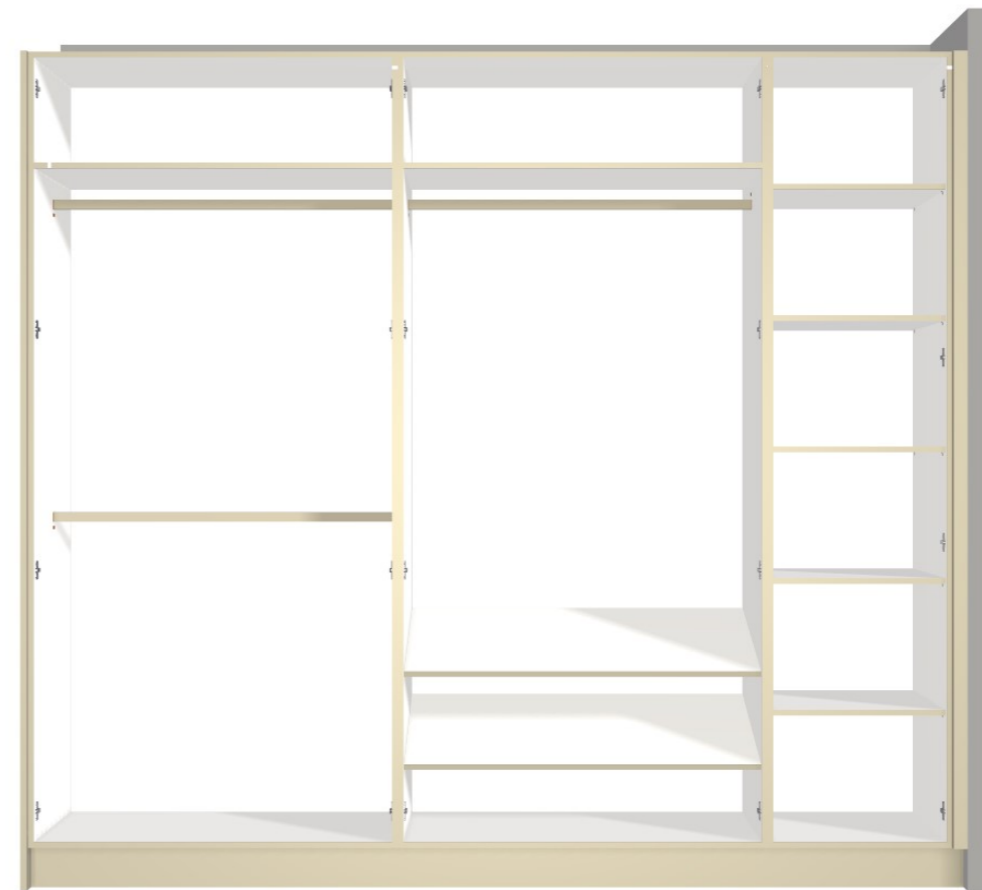
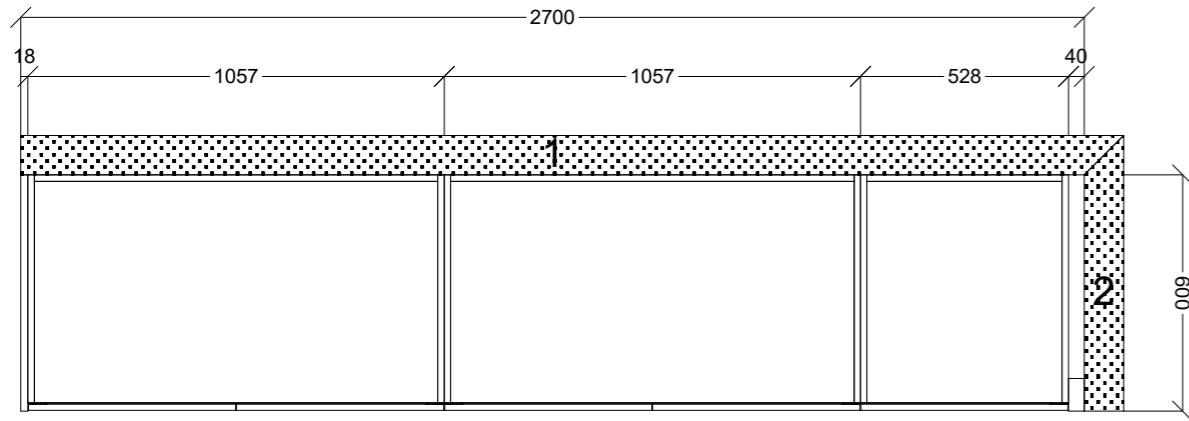

	Client: JAMES JACOBSON		Door and panels style/colour: TESROL 504 EP3S RAW MDF		Sheet 4 of 4
	Room: ROBE	Benchtop Colour: N/A		Drawer slides: N/A	Carcass: WHITE HMR
	Date: 27/09/23	Address: 91 BULLEEN RD NTH BALWYN		Handles Item No: BY CUSTOMER	Approved by: