

WIR 1

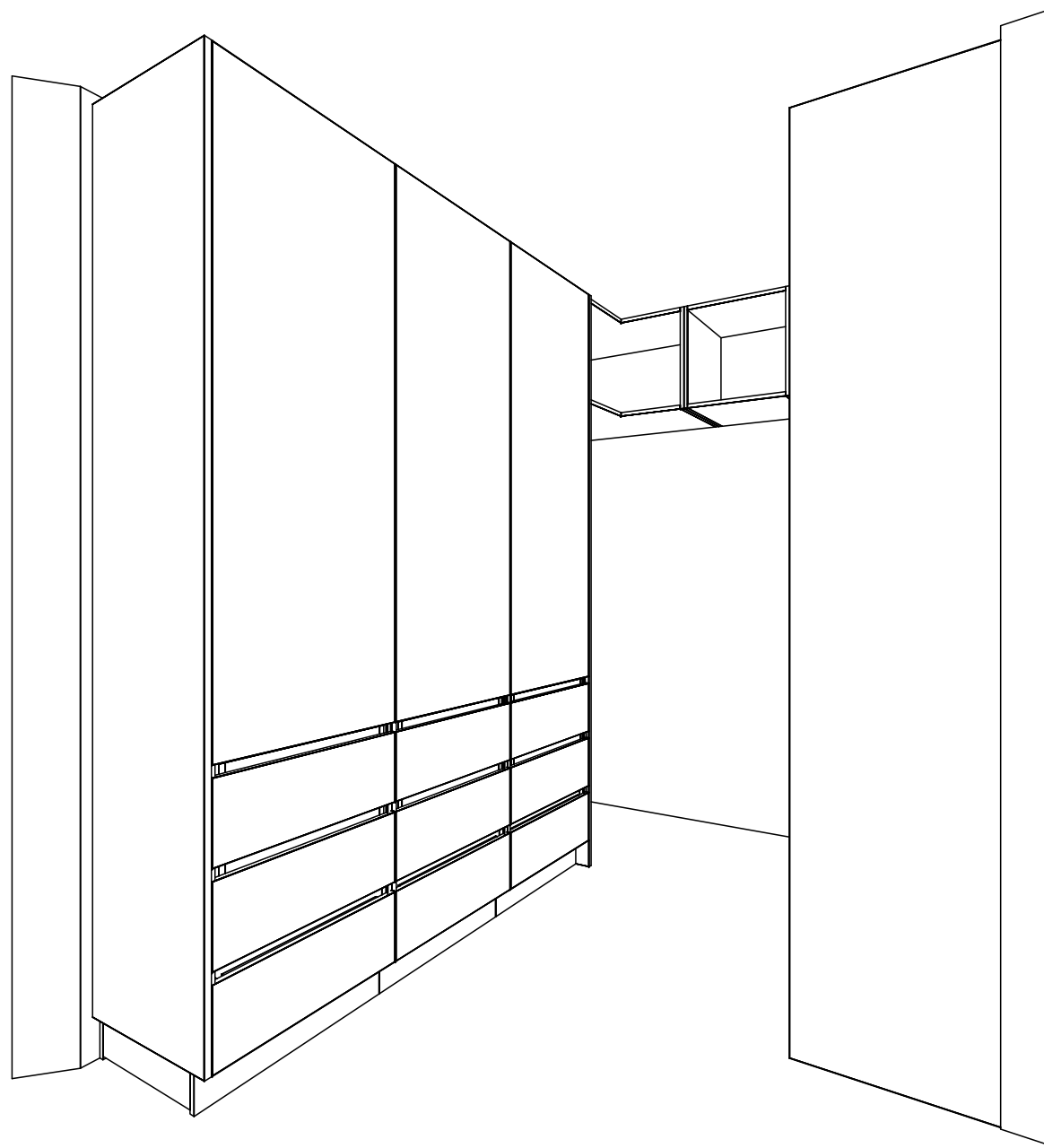

Phone: 0432 101 986

Job #: Job

Site Contact:

Date: 07/05/24

SJ Custom Kitchens

Email: sjcustomkitchens@hotmail.com

Job Name: Default

Site Phone:

Drawn By:

Web: www.sjcustomkitchens.com

Room #:

Site Address:

Drawing #: 5

Room Name:

City:

State: Victoria.

Scale: NTS

WIR 1

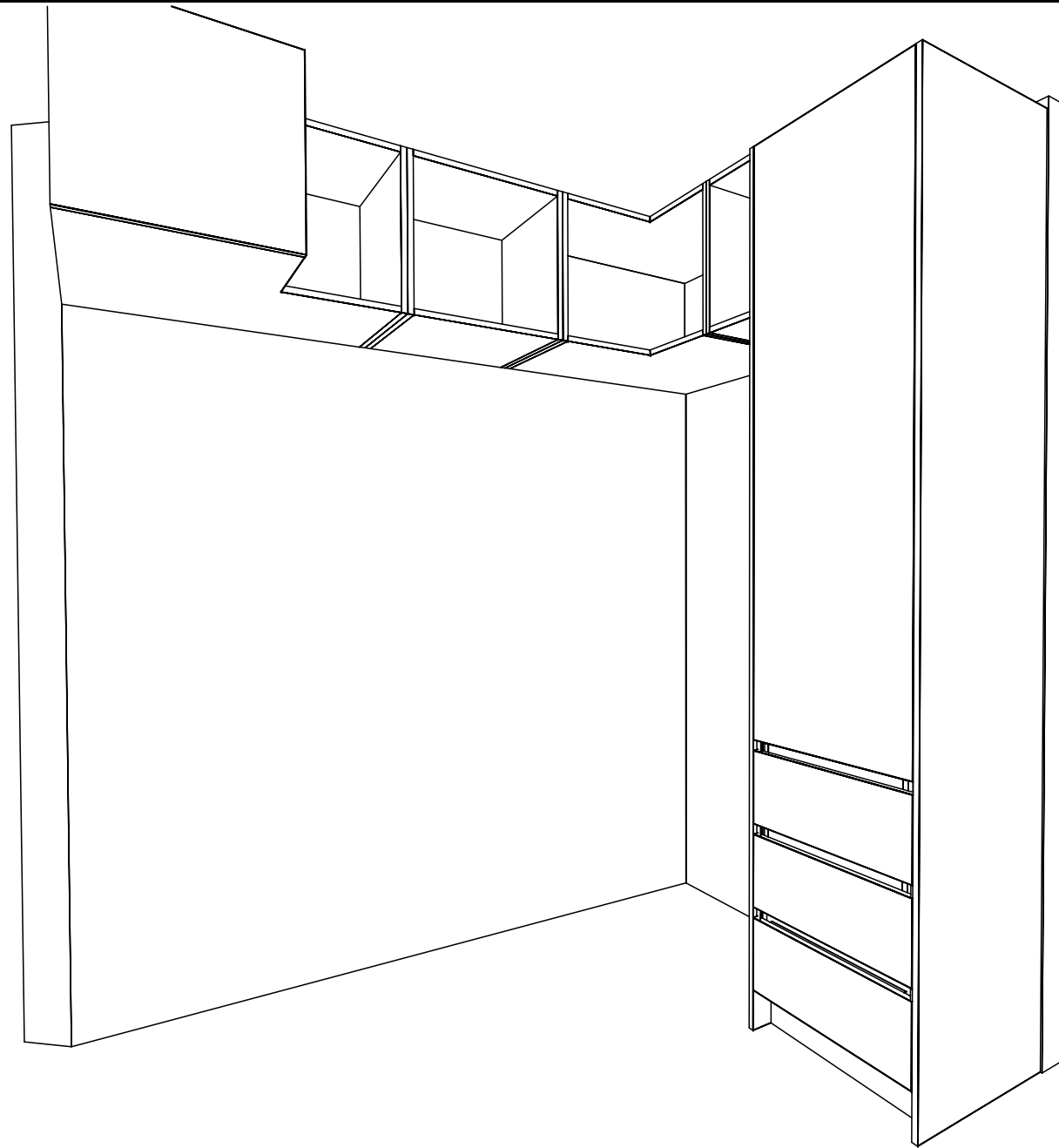

SJ Custom Kitchens	Phone: 0432 101 986	Job #: Job	Site Contact:	Date: 07/05/24
	Email: sjcustomkitchens@hotmail.com	Job Name: Default	Site Phone:	Drawn By:
	Web: www.sjcustomkitchens.com	Room #:	Site Address:	Drawing #: 6
		Room Name:	City: Victoria.	Scale: NTS

WIR 1

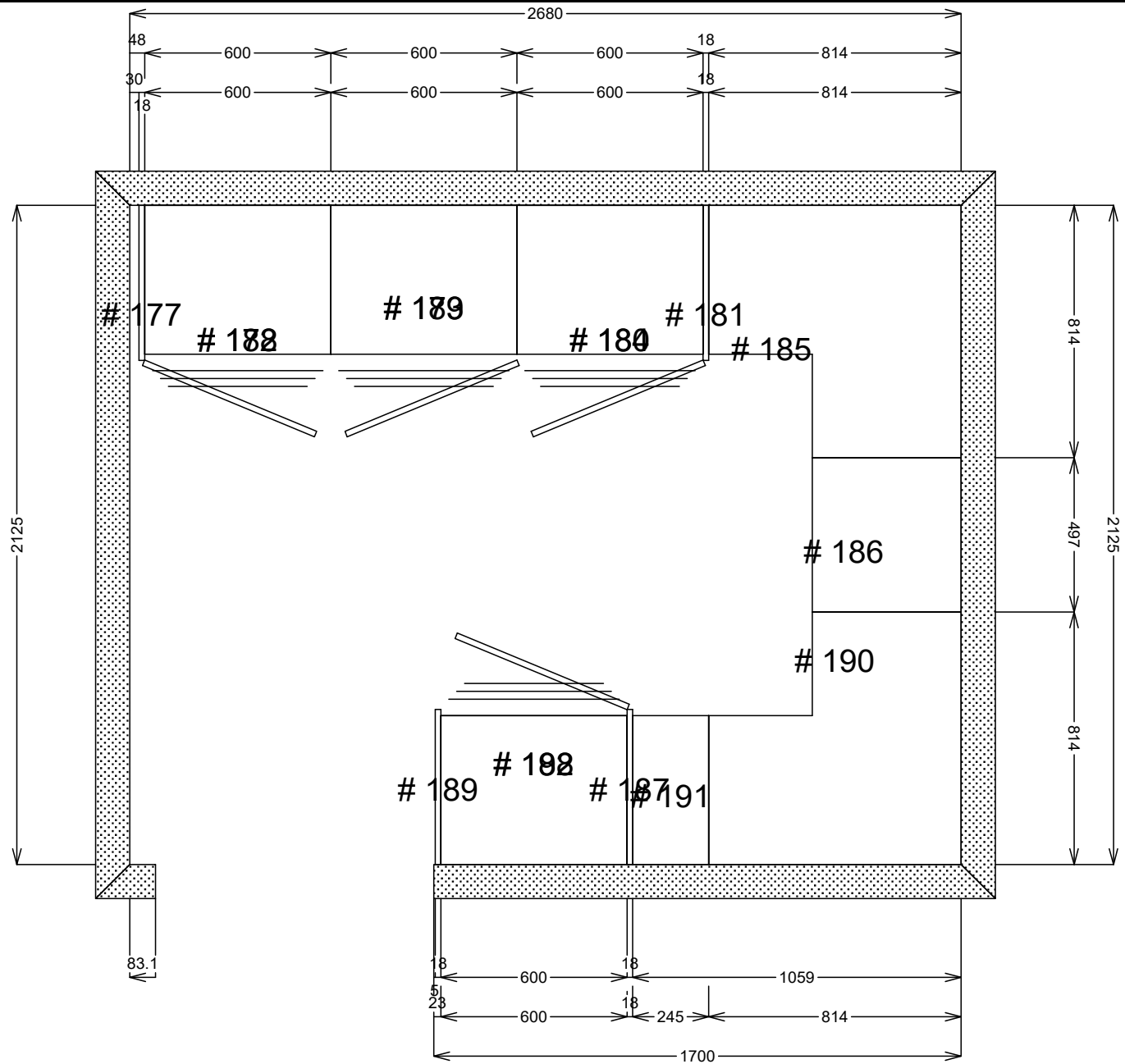

Phone: 0432 101 986

Job #: Job

Site Contact:

Date: 07/05/24

SJ Custom Kitchens

Email: sjcustomkitchens@hotmail.com

Job Name: Default

Site Phone:

Drawn By:

Web: www.sjcustomkitchens.com

Room #:

Site Address:

Drawing #: 7

Room Name:

City:

State: Victoria.

Scale: NTS

WIR 1

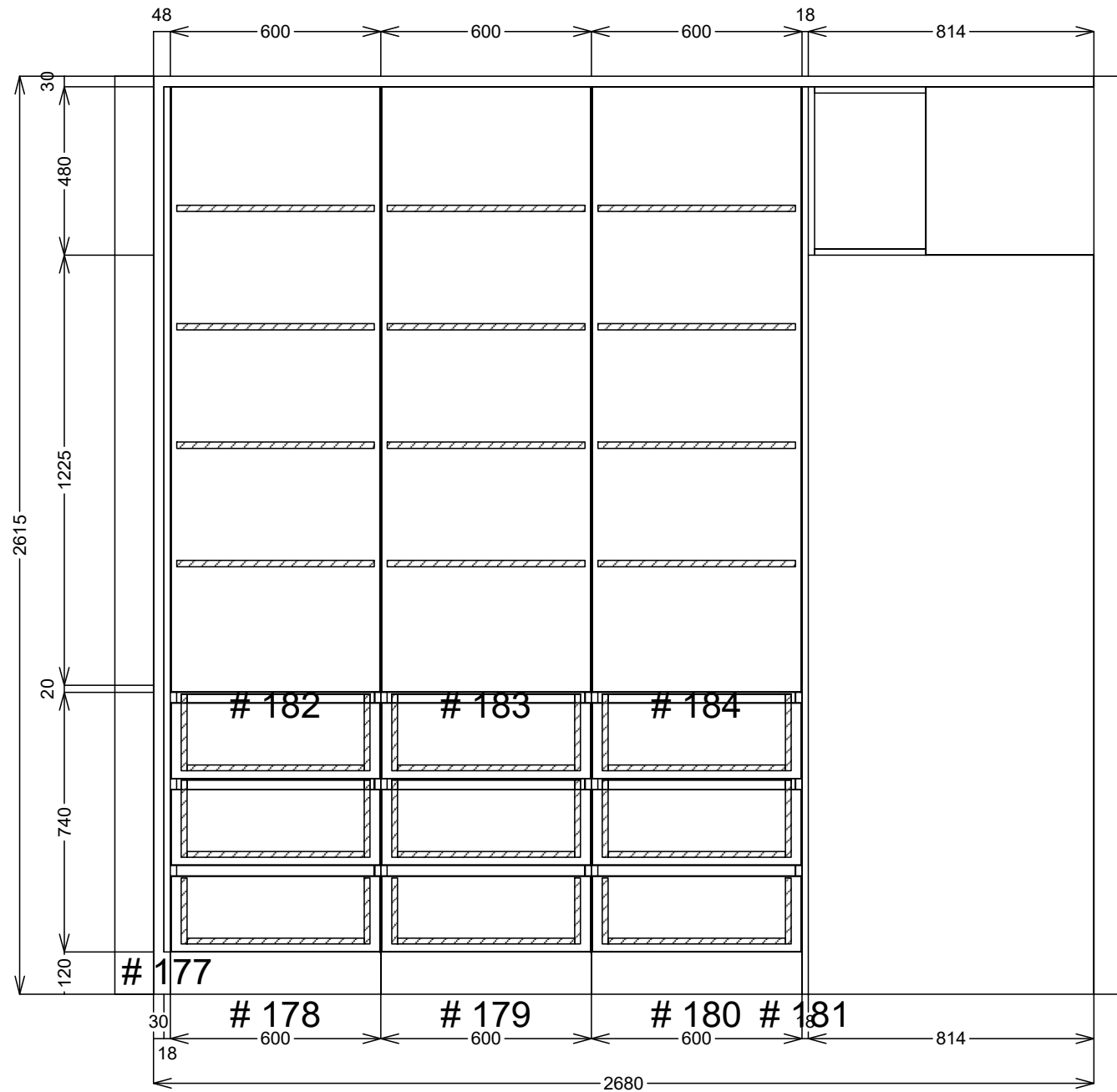

SJ Custom Kitchens	Phone: 0432 101 986	Job #: Job	Site Contact:	Date: 07/05/24
	Email: sjcustomkitchens@hotmail.com	Job Name: Default	Site Phone:	Drawn By:
	Web: www.sjcustomkitchens.com	Room #:	Site Address:	Drawing #: 8
		Room Name:	City: State: Victoria.	Scale: NTS

WIR 1

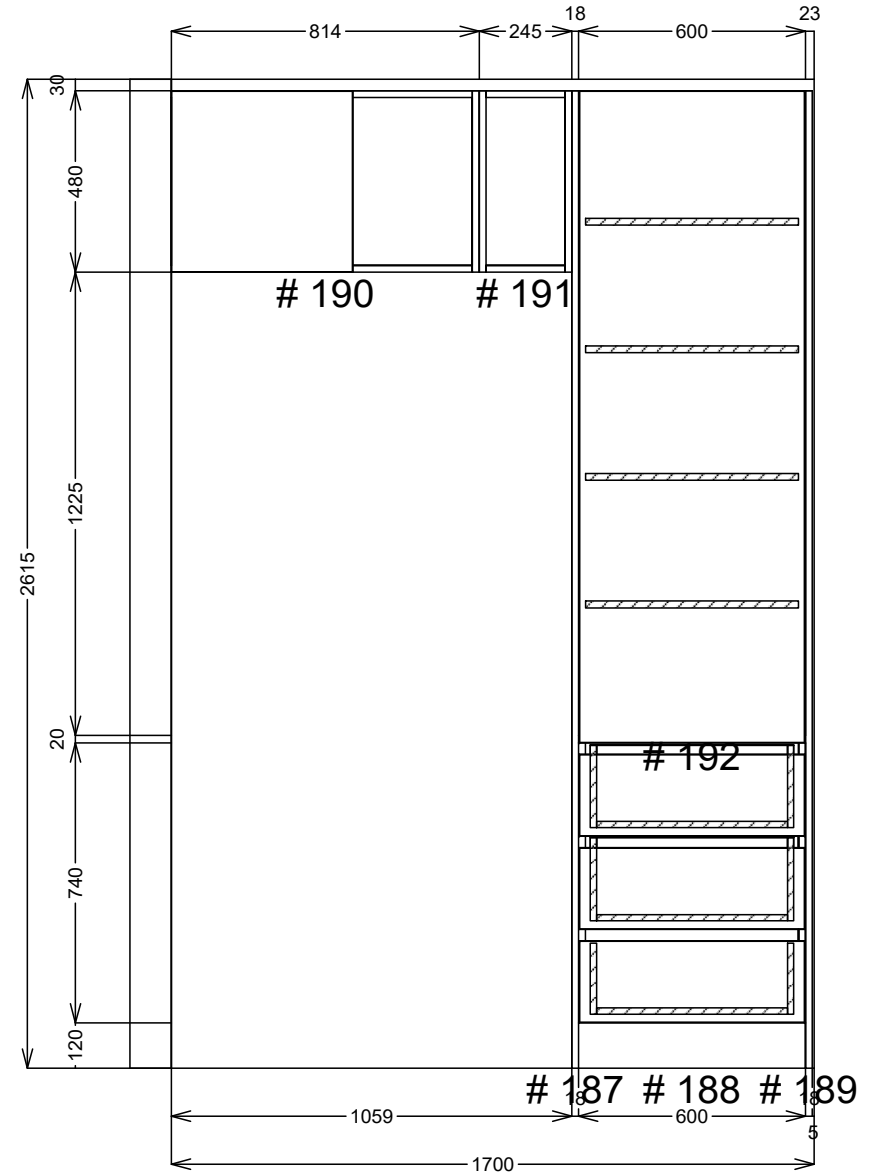
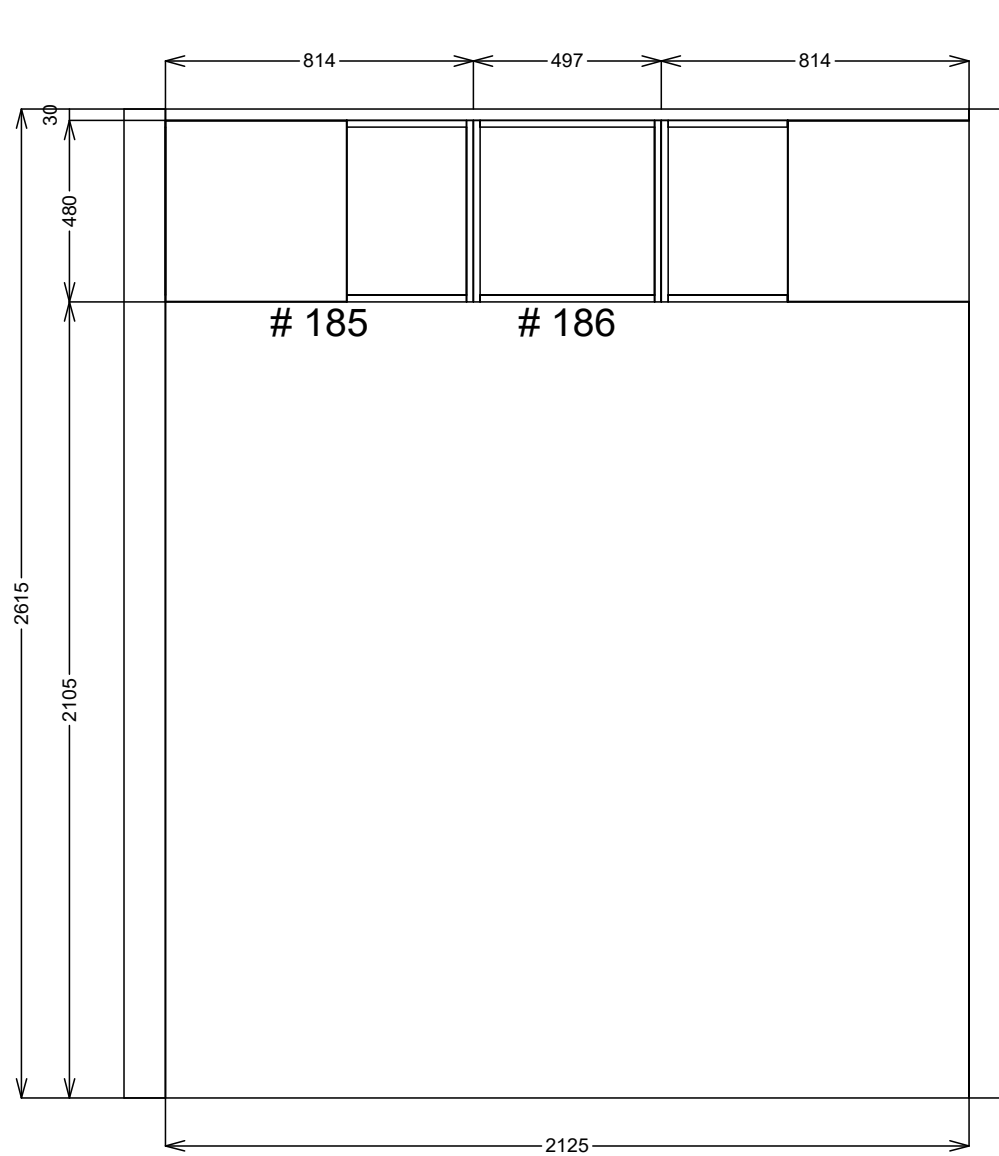

SJ Custom Kitchens	Phone: 0432 101 986	Job #: Job	Site Contact:	Date: 07/05/24
	Email: sjcustomkitchens@hotmail.com	Job Name: Default	Site Phone:	Drawn By:
	Web: www.sjcustomkitchens.com	Room #:	Site Address:	Drawing #: 9
		Room Name:	City: Victoria.	Scale: NTS

BIR 1

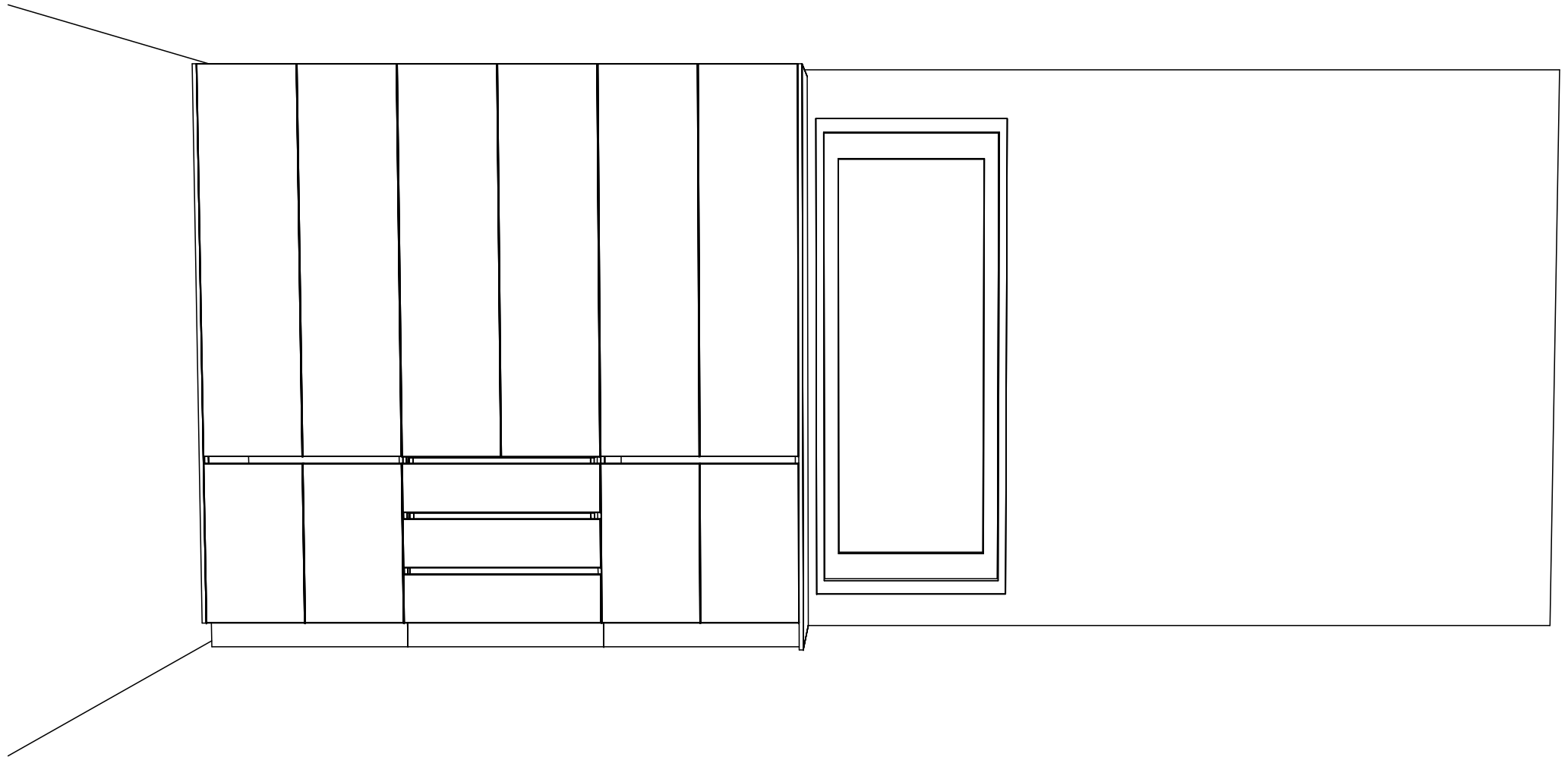

Phone: 0432 101 986

Job #: Job

Site Contact:

Date: 07/05/24

SJ Custom Kitchens

Email: sjcustomkitchens@hotmail.com

Job Name: Default

Site Phone:

Drawn By:

Web: www.sjcustomkitchens.com

Room #:

Site Address:

Drawing #: 10

Room Name:

City:

State: Victoria.

Scale: NTS

BIR 1

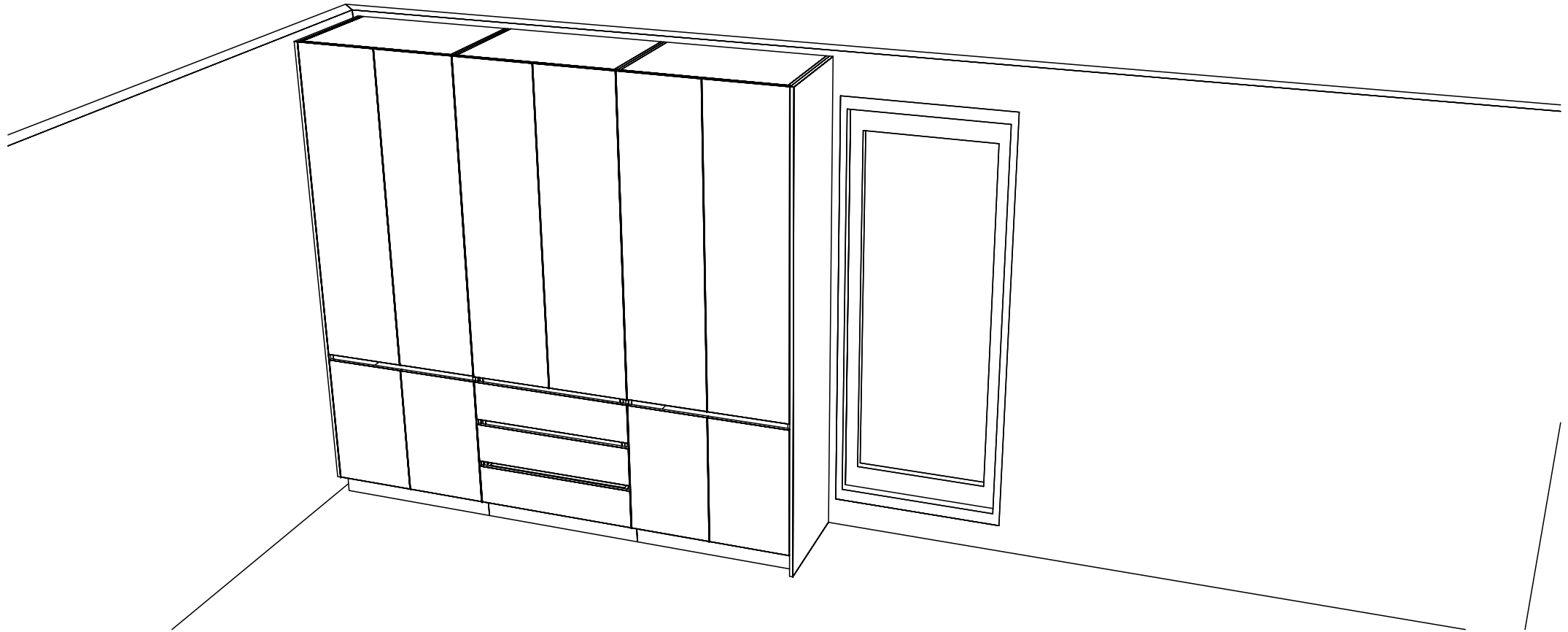

Phone: 0432 101 986

Job #: Job

Site Contact:

Date: 07/05/24

SJ Custom Kitchens

Email: sjcustomkitchens@hotmail.com

Job Name: Default

Site Phone:

Drawn By:

Web: www.sjcustomkitchens.com

Room #:

Site Address:

Drawing #: 11

Room Name:

City:

State: Victoria.

Scale: NTS

BIR 1

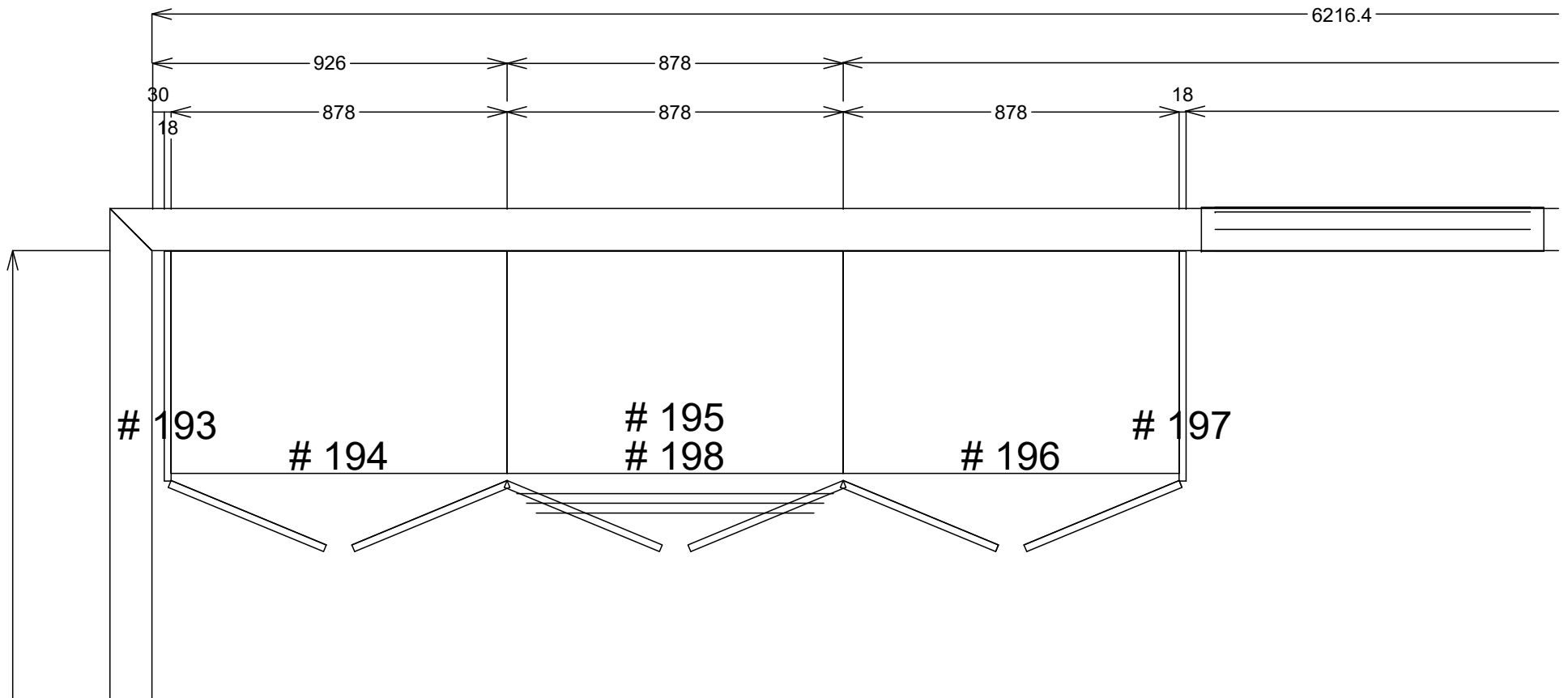

SJ Custom Kitchens	Phone: 0432 101 986	Job #: Job	Site Contact:	Date: 07/05/24
	Email: sjcustomkitchens@hotmail.com	Job Name: Default	Site Phone:	Drawn By:
	Web: www.sjcustomkitchens.com	Room #:	Site Address:	Drawing #: 12
		Room Name:	City: State: Victoria.	Scale: NTS

BIR 1

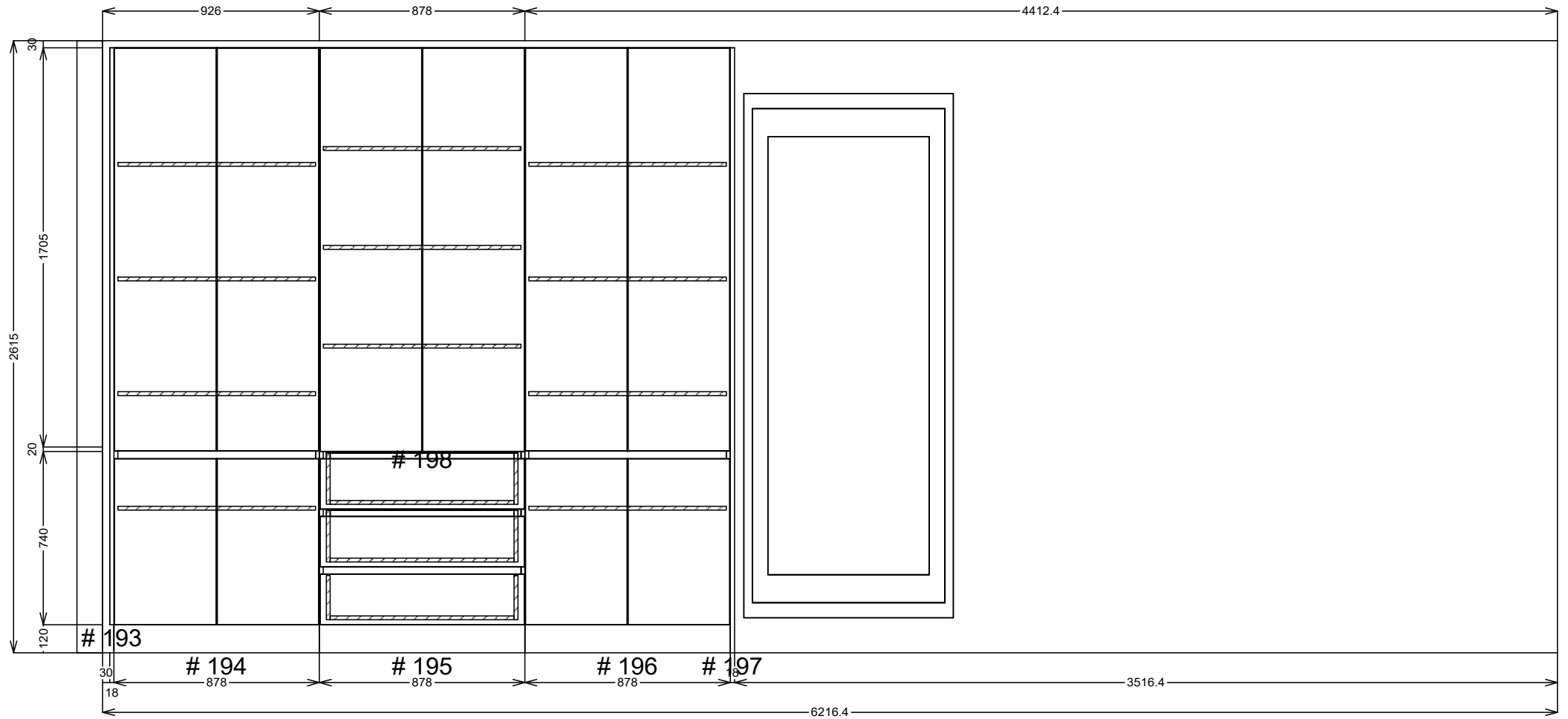

SJ Custom Kitchens	Phone: 0432 101 986	Job #: Job	Site Contact:	Date: 07/05/24
	Email: sjcustomkitchens@hotmail.com	Job Name: Default	Site Phone:	Drawn By:
	Web: www.sjcustomkitchens.com	Room #:	Site Address:	Drawing #: 13
		Room Name:	City: Victoria.	Scale: NTS

BIR 2

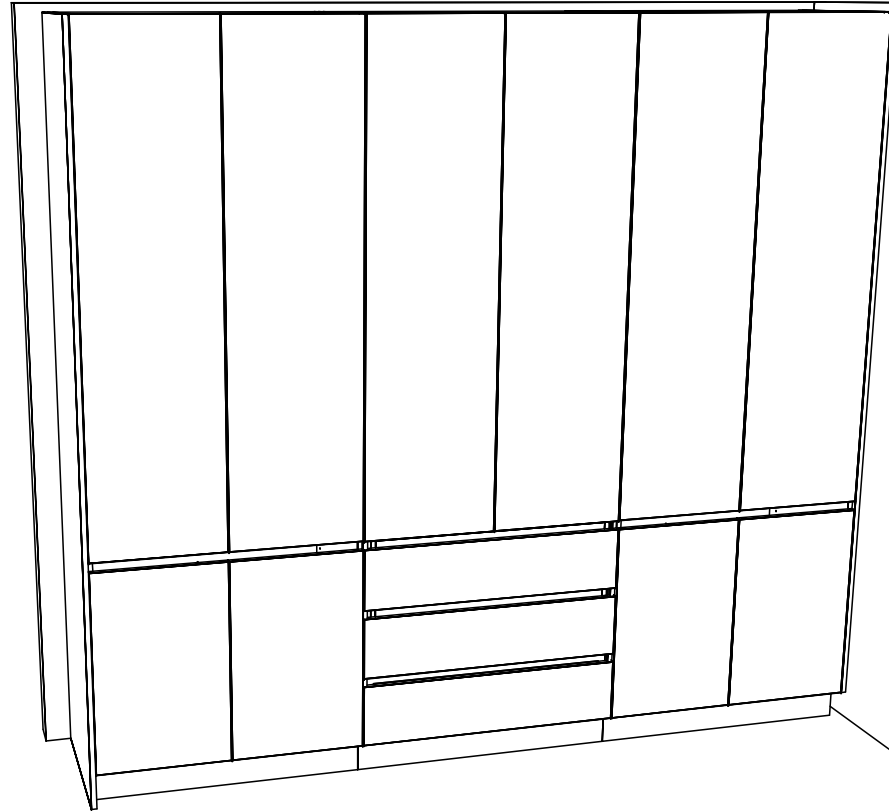
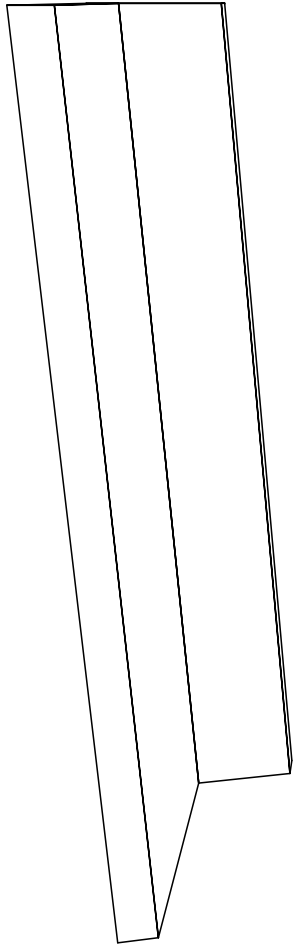

SJ Custom Kitchens	Phone: 0432 101 986	Job #: Job	Site Contact:	Date: 07/05/24
	Email: sjcustomkitchens@hotmail.com	Job Name: Default	Site Phone:	Drawn By:
	Web: www.sjcustomkitchens.com	Room #:	Site Address:	Drawing #: 14
		Room Name:	City: State: Victoria.	Scale: NTS

BIR 2

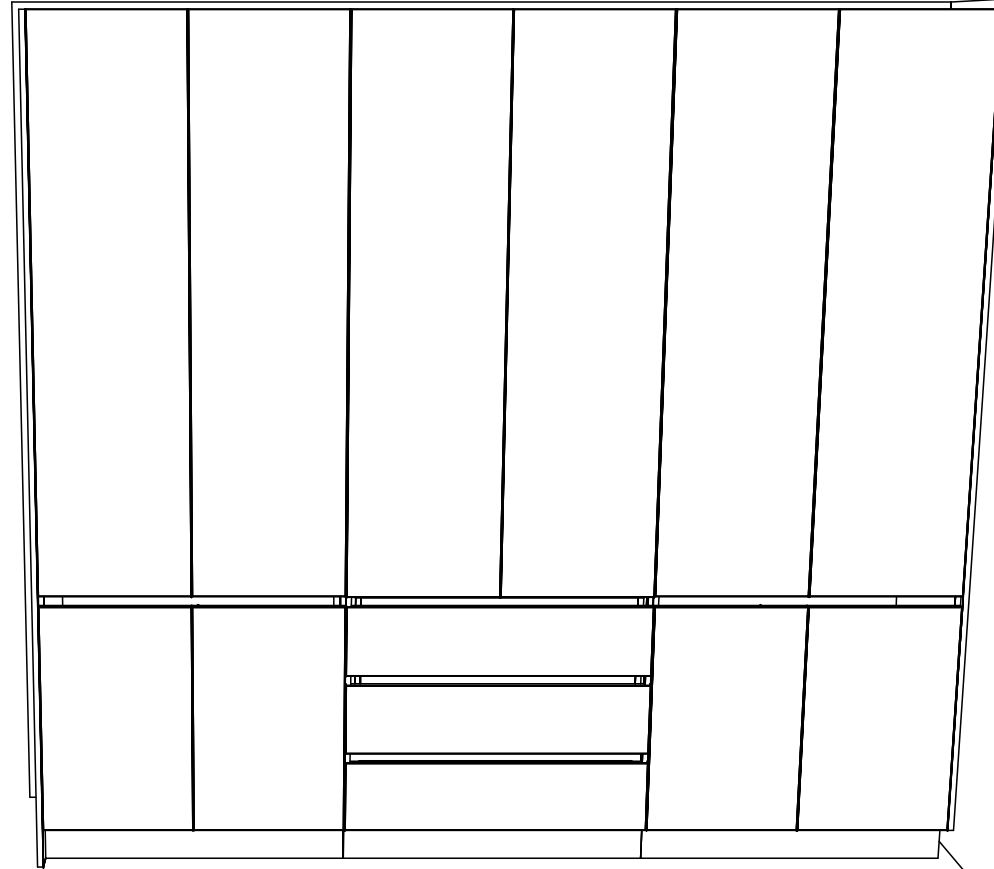
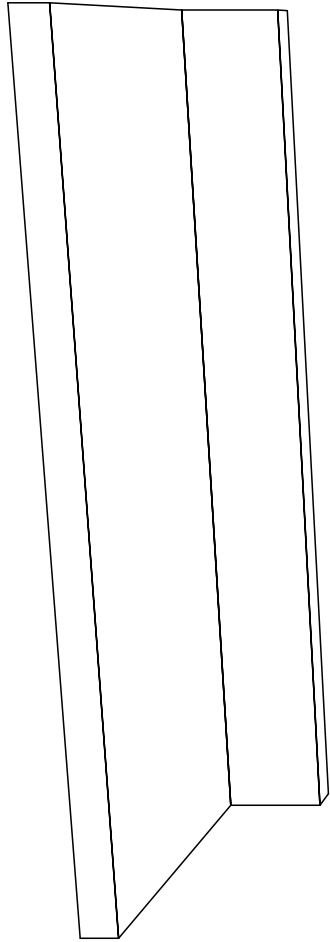

Phone: 0432 101 986

Job #: Job

Site Contact:

Date: 07/05/24

SJ Custom Kitchens

Email: sjcustomkitchens@hotmail.com

Job Name: Default

Site Phone:

Drawn By:

Web: www.sjcustomkitchens.com

Room #:

Site Address:

Drawing #: 15

Room Name:

City:

State: Victoria.

Scale: NTS

BIR 2

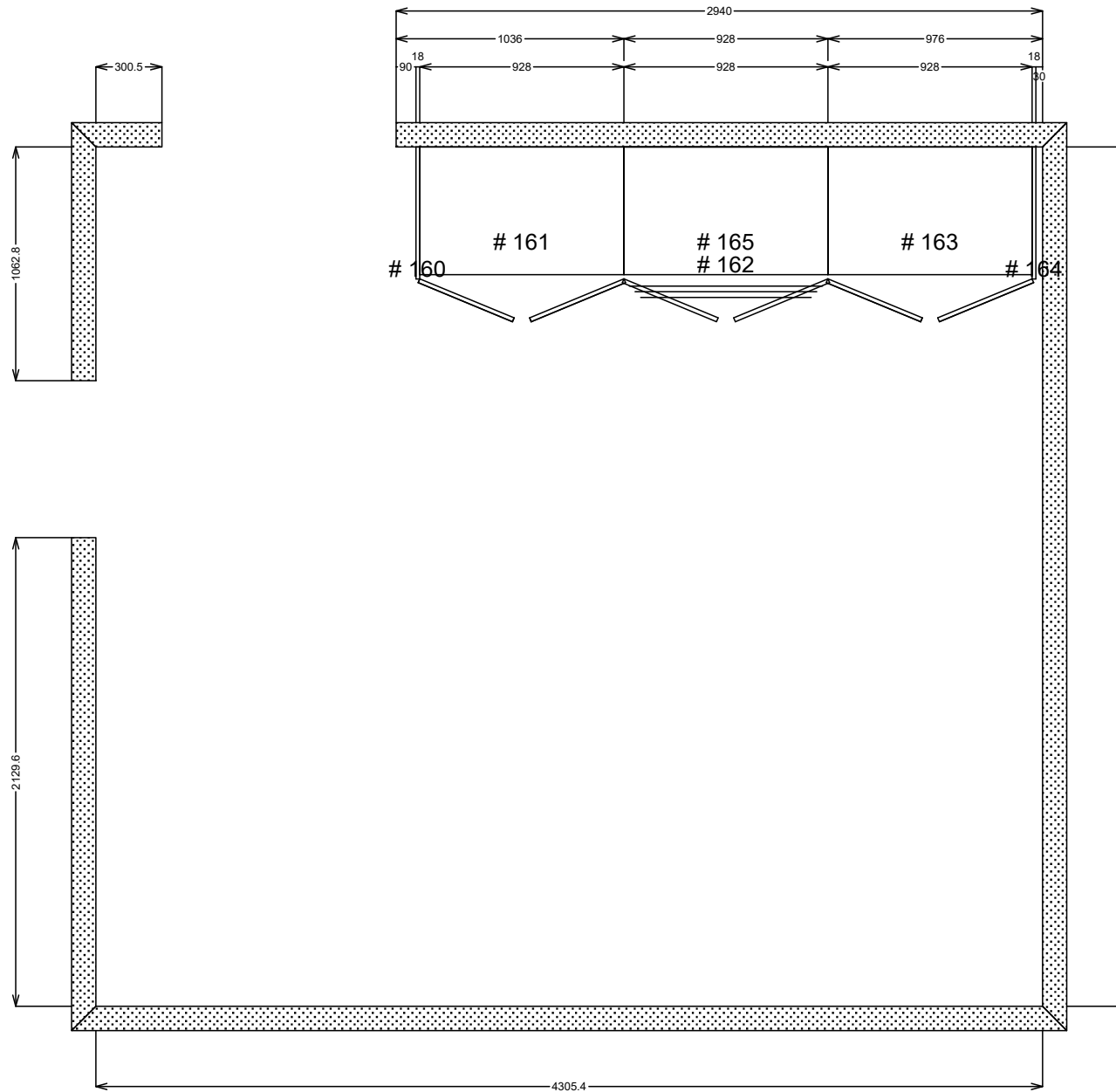

Phone: 0432 101 986

Job #: Job

Site Contact:

Date: 07/05/24

SJ Custom Kitchens

Email: sjcustomkitchens@hotmail.com

Job Name: Default

Site Phone:

Drawn By:

Web: www.sjcustomkitchens.com

Room #:

Site Address:

Drawing #: 16

Room Name:

City:

State: Victoria.

Scale: NTS

BIR 2

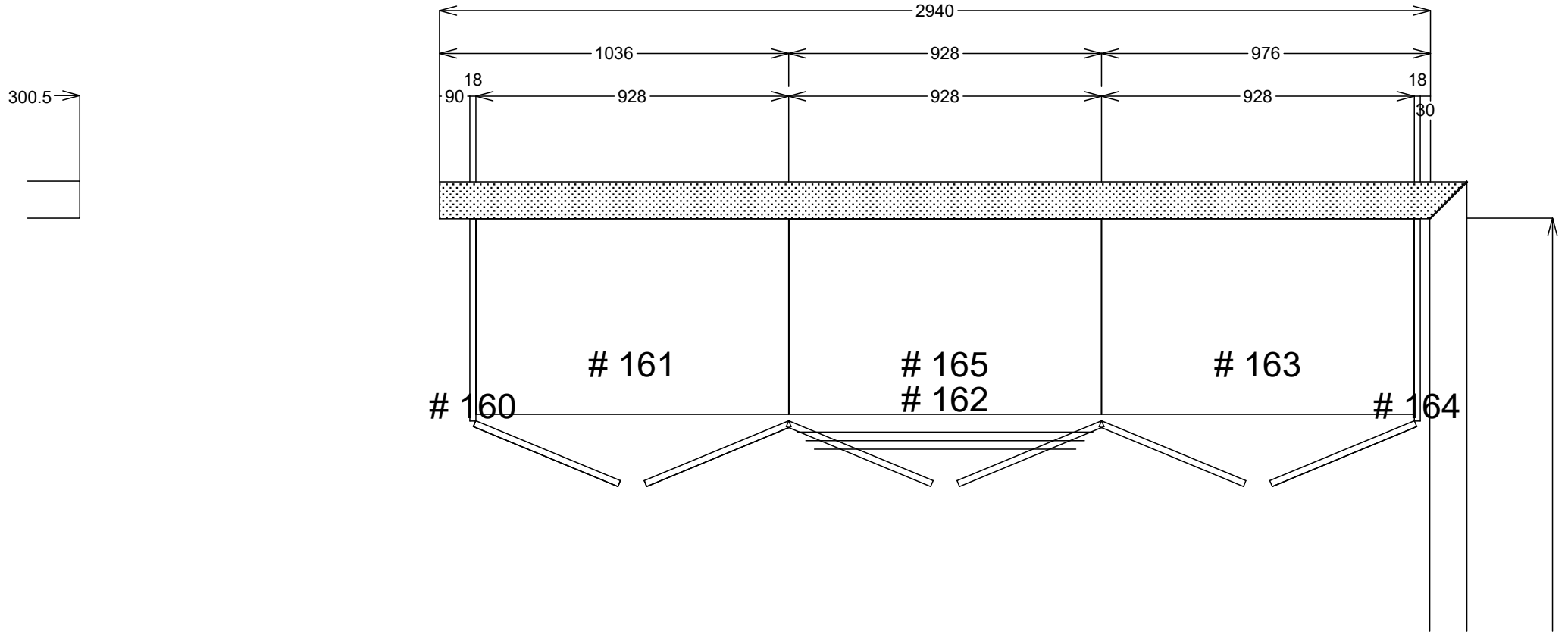

SJ Custom Kitchens	Phone: 0432 101 986	Job #: Job	Site Contact:	Date: 07/05/24
	Email: sjcustomkitchens@hotmail.com	Job Name: Default	Site Phone:	Drawn By:
	Web: www.sjcustomkitchens.com	Room #:	Site Address:	Drawing #: 17
		Room Name:	City: State: Victoria.	Scale: NTS

BIR 2

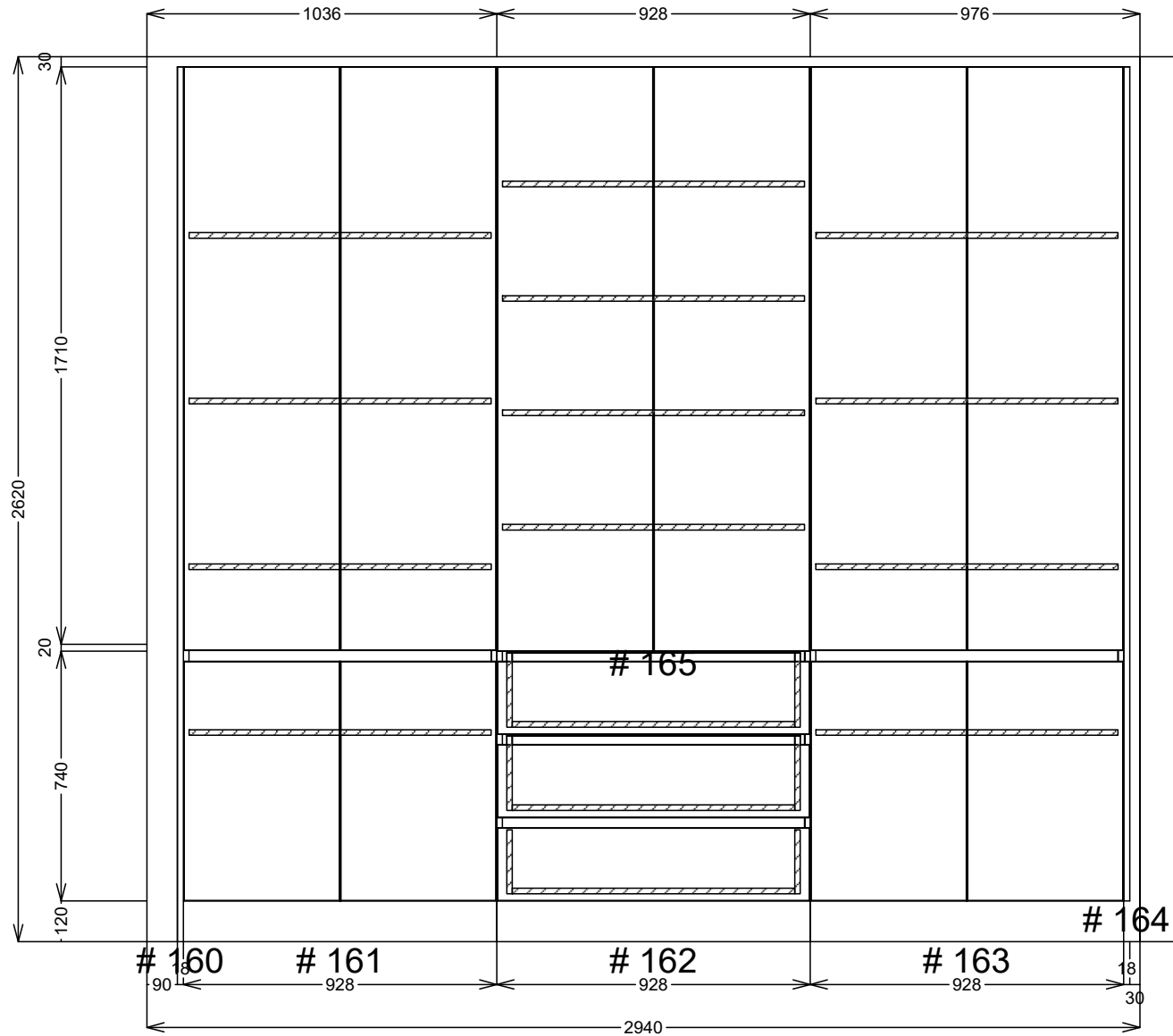

SJ Custom Kitchens	Phone: 0432 101 986	Job #: Job	Site Contact:	Date: 07/05/24
	Email: sjcustomkitchens@hotmail.com	Job Name: Default	Site Phone:	Drawn By:
	Web: www.sjcustomkitchens.com	Room #:	Site Address:	Drawing #: 18
		Room Name:	City: Victoria.	Scale: NTS