

| | | | | |
|---------------------------|-------------------------------------|-------------------|--|----------------|
| SJ Custom Kitchens | Phone: 0432 101 986 | Job #: Job | Site Contact: Darren | Date: 04/06/24 |
| | Email: sjcustomkitchens@hotmail.com | Job Name: Default | Site Phone: | Drawn By: |
| | Web: www.sjcustomkitchens.com | Room #: | Site Address: 264 Spring Road | Drawing #: 1 |
| | | Room Name: | City: Dingley Village State: Victoria. | Scale: NTS |

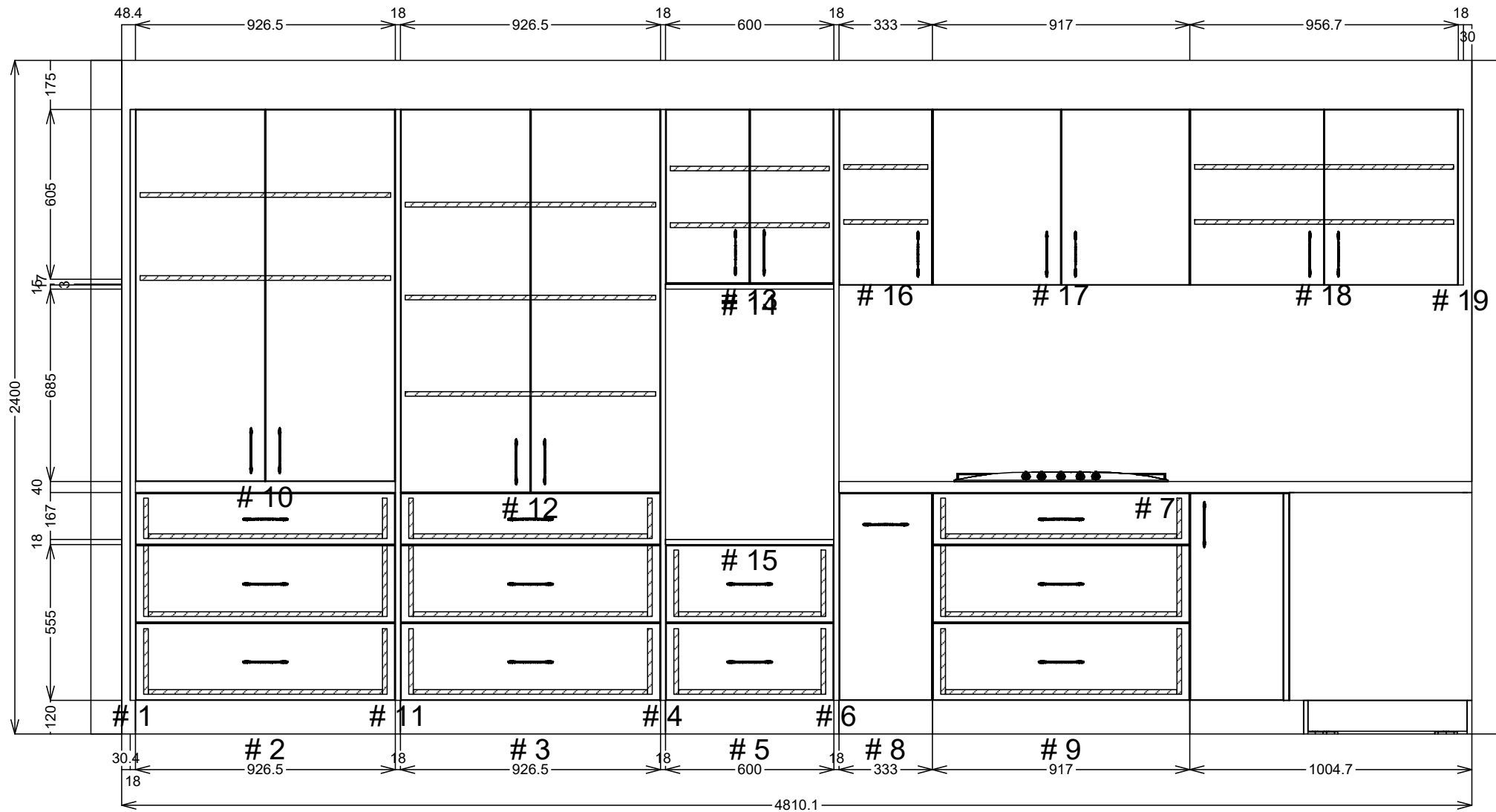

| | | | | |
|---------------------------|-------------------------------------|-------------------|--|----------------|
| SJ Custom Kitchens | Phone: 0432 101 986 | Job #: Job | Site Contact: Darren | Date: 04/06/24 |
| | Email: sjcustomkitchens@hotmail.com | Job Name: Default | Site Phone: | Drawn By: |
| | Web: www.sjcustomkitchens.com | Room #: | Site Address: 264 Spring Road | Drawing #: 2 |
| | | Room Name: | City: Dingley Village State: Victoria. | Scale: NTS |

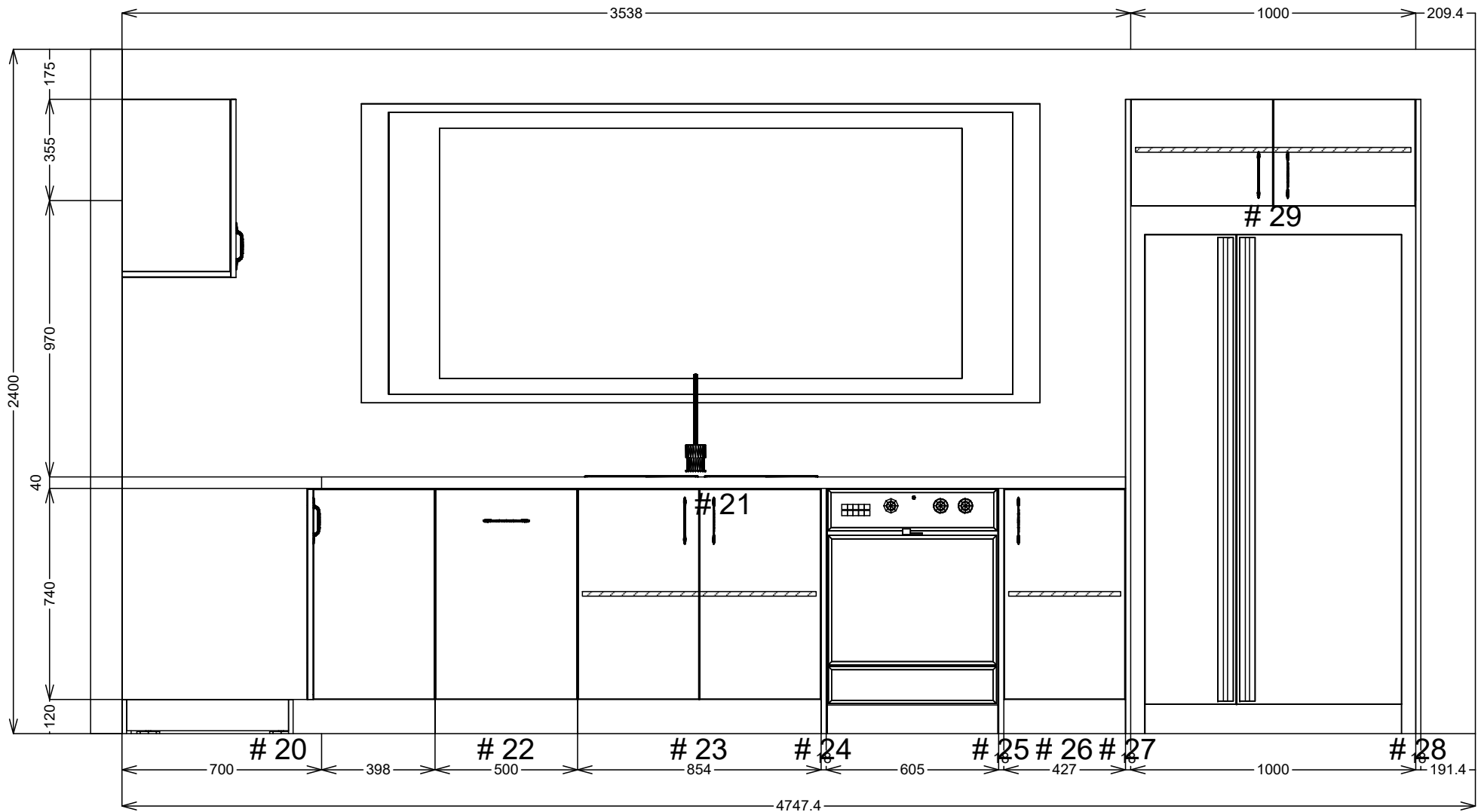

| | | | | |
|---------------------------|-------------------------------------|-------------------|--|----------------|
| SJ Custom Kitchens | Phone: 0432 101 986 | Job #: Job | Site Contact: Darren | Date: 04/06/24 |
| | Email: sjcustomkitchens@hotmail.com | Job Name: Default | Site Phone: | Drawn By: |
| | Web: www.sjcustomkitchens.com | Room #: | Site Address: 264 Spring Road | Drawing #: 3 |
| | | Room Name: | City: Dingley Village State: Victoria. | Scale: NTS |

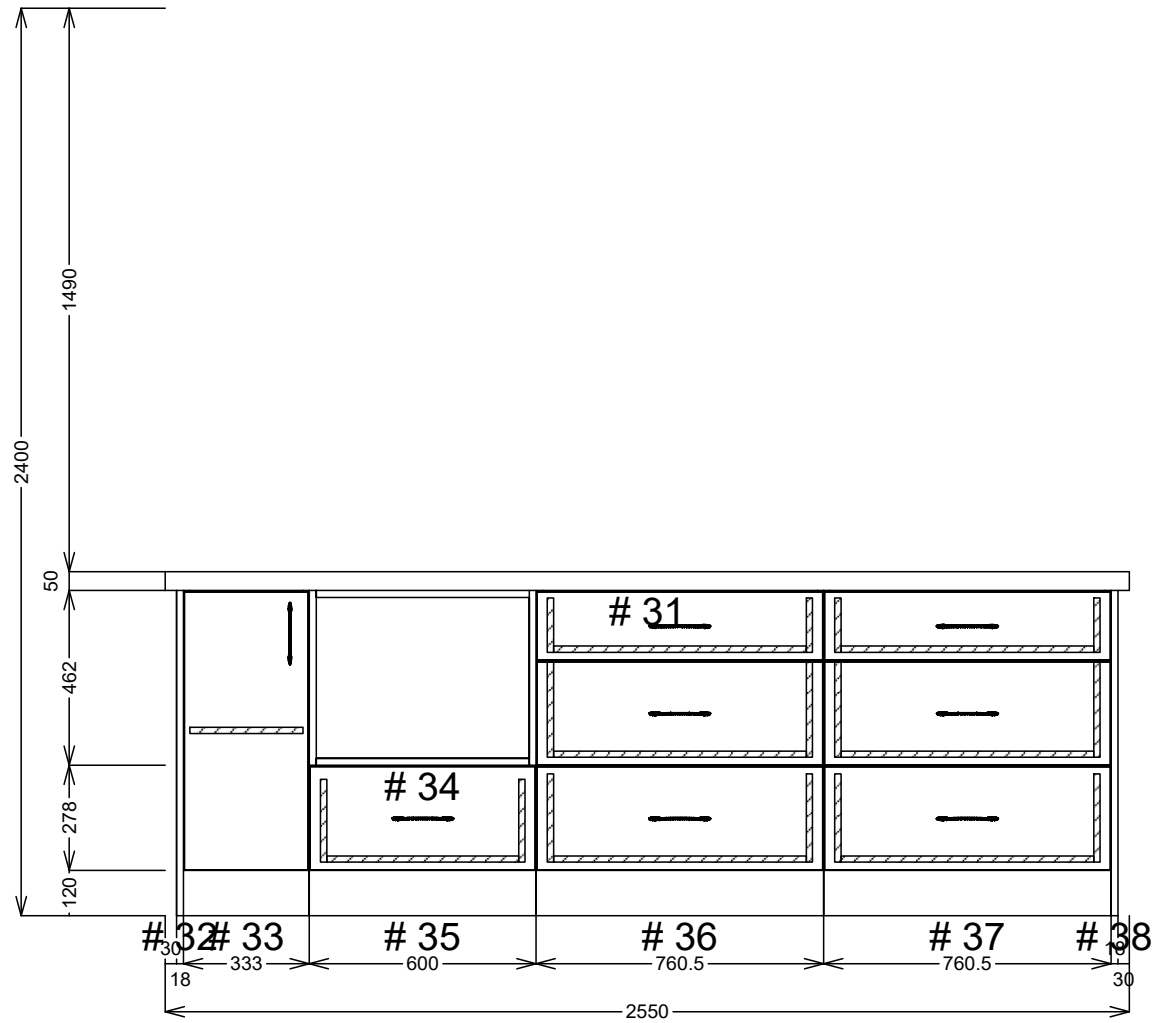

| | | | | |
|---------------------------|-------------------------------------|-------------------|--|----------------|
| SJ Custom Kitchens | Phone: 0432 101 986 | Job #: Job | Site Contact: Darren | Date: 04/06/24 |
| | Email: sjcustomkitchens@hotmail.com | Job Name: Default | Site Phone: | Drawn By: |
| | Web: www.sjcustomkitchens.com | Room #: | Site Address: 264 Spring Road | Drawing #: 4 |
| | | Room Name: | City: Dingley Village State: Victoria. | Scale: NTS |

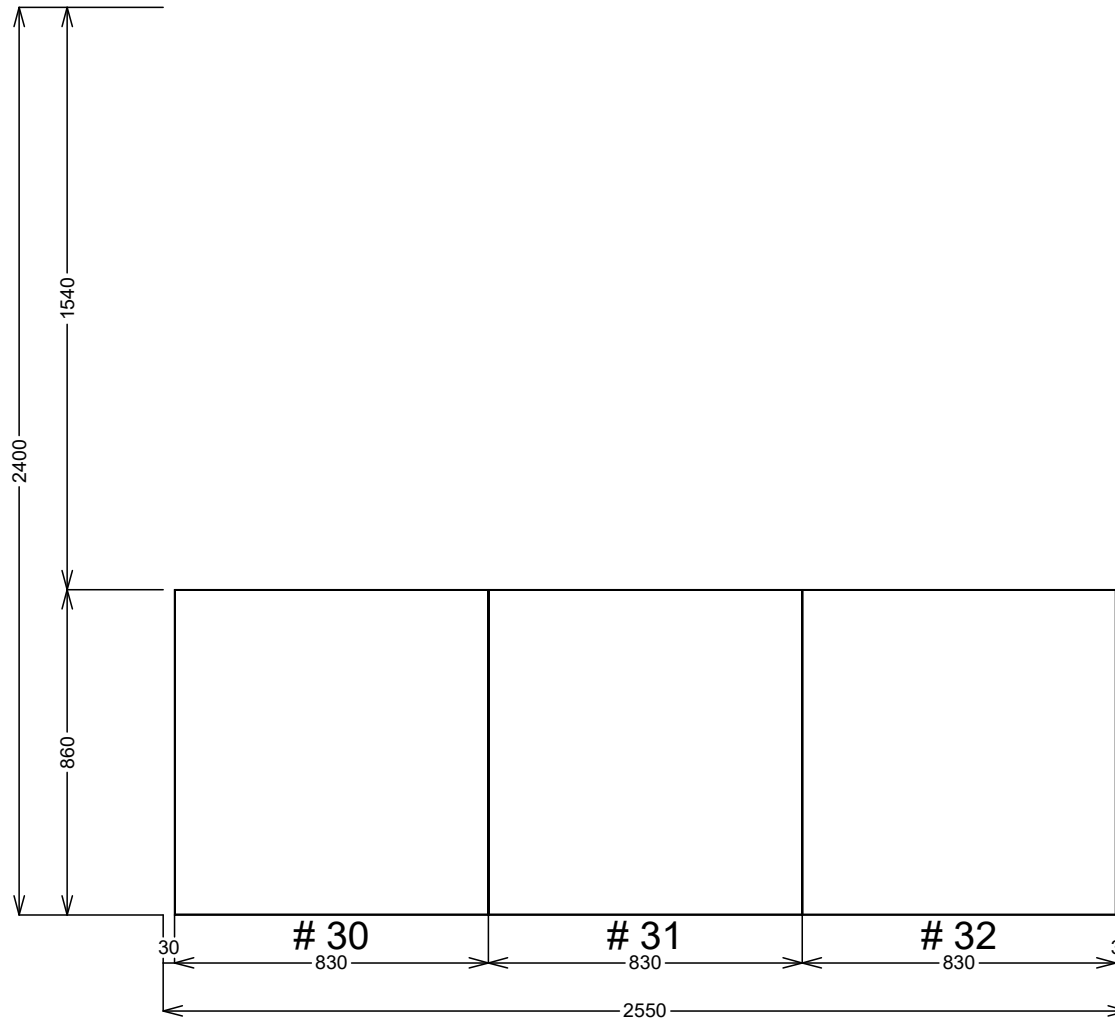

| | | | | |
|---------------------------|-------------------------------------|-------------------|--|----------------|
| SJ Custom Kitchens | Phone: 0432 101 986 | Job #: Job | Site Contact: Darren | Date: 04/06/24 |
| | Email: sjcustomkitchens@hotmail.com | Job Name: Default | Site Phone: | Drawn By: |
| | Web: www.sjcustomkitchens.com | Room #: | Site Address: 264 Spring Road | Drawing #: 5 |
| | | Room Name: | City: Dingley Village State: Victoria. | Scale: NTS |

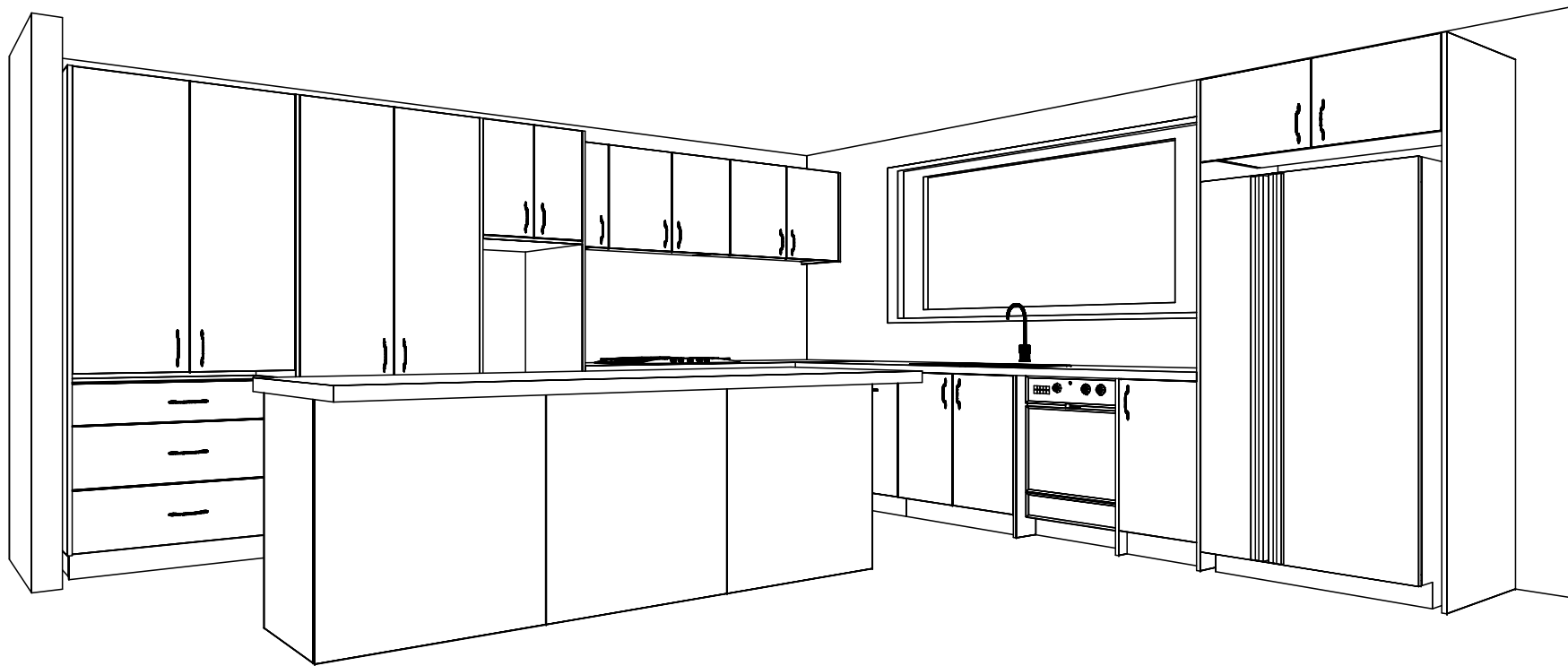

| | | | | |
|---------------------------|-------------------------------------|-------------------|--|----------------|
| SJ Custom Kitchens | Phone: 0432 101 986 | Job #: Job | Site Contact: Darren | Date: 04/06/24 |
| | Email: sjcustomkitchens@hotmail.com | Job Name: Default | Site Phone: | Drawn By: |
| | Web: www.sjcustomkitchens.com | Room #: | Site Address: 264 Spring Road | Drawing #: 6 |
| | | Room Name: | City: Dingley Village State: Victoria. | Scale: NTS |

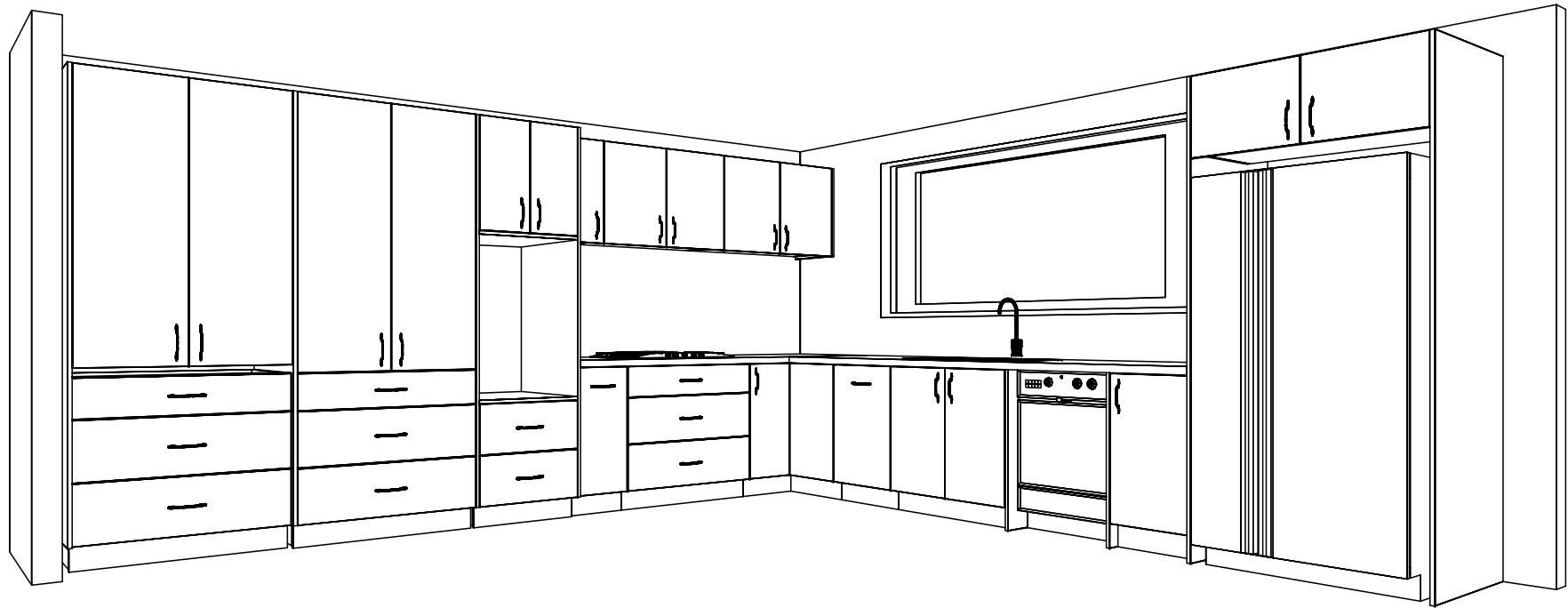

| | | | | |
|---------------------------|-------------------------------------|-------------------|--|----------------|
| SJ Custom Kitchens | Phone: 0432 101 986 | Job #: Job | Site Contact: Darren | Date: 04/06/24 |
| | Email: sjcustomkitchens@hotmail.com | Job Name: Default | Site Phone: | Drawn By: |
| | Web: www.sjcustomkitchens.com | Room #: | Site Address: 264 Spring Road | Drawing #: 7 |
| | | Room Name: | City: Dingley Village State: Victoria. | Scale: NTS |

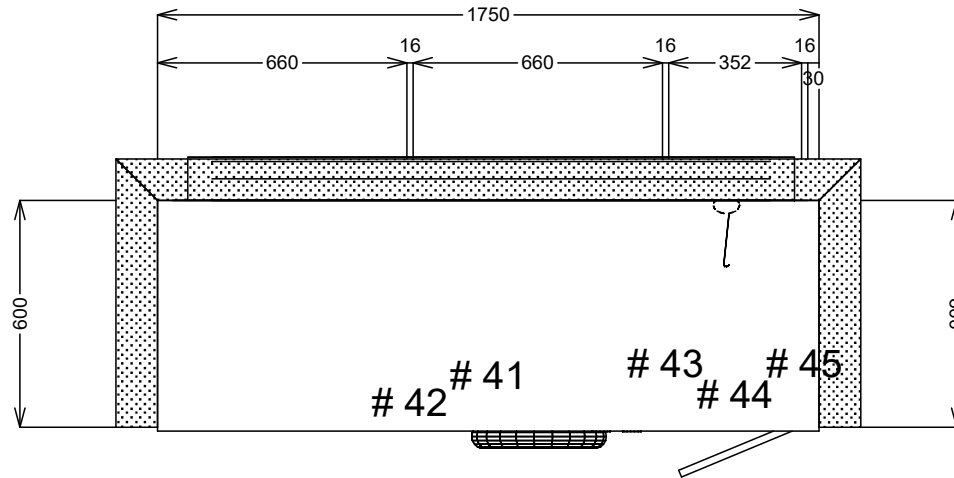

| | | | | |
|---------------------------|-------------------------------------|-------------------|--|----------------|
| SJ Custom Kitchens | Phone: 0432 101 986 | Job #: Job | Site Contact: Darren | Date: 04/06/24 |
| | Email: sjcustomkitchens@hotmail.com | Job Name: Default | Site Phone: | Drawn By: |
| | Web: www.sjcustomkitchens.com | Room #: | Site Address: 264 Spring Road | Drawing #: 8 |
| | | Room Name: | City: Dingley Village State: Victoria. | Scale: NTS |

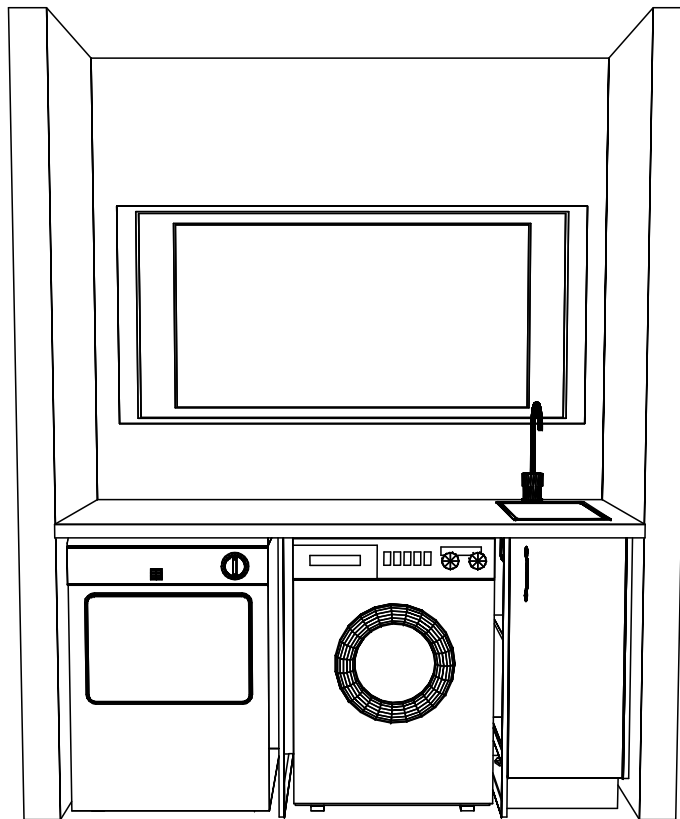

| | | | | |
|---------------------------|-------------------------------------|-------------------|--|----------------|
| SJ Custom Kitchens | Phone: 0432 101 986 | Job #: Job | Site Contact: Darren | Date: 04/06/24 |
| | Email: sjcustomkitchens@hotmail.com | Job Name: Default | Site Phone: | Drawn By: |
| | Web: www.sjcustomkitchens.com | Room #: | Site Address: 264 Spring Road | Drawing #: 10 |
| | | Room Name: | City: Dingley Village State: Victoria. | Scale: NTS |