

IRWIN H.
DESIGN. INTERIOR

DESIGNED BY
IRWIN
Melbourne, Australia
EMAIL
irwin.h.o@gmail.com

CLIENT
SHERMAN LOO & HO LEE SING
2/85 MANNINGHAM ST
PARKVILLE
VIC 3023

PROJECT
KITCHEN, PANTRY AND DINING
JOINERY

DRAWN BY
IH

ISSUE
18.04.2024(T0)

REISSUE
NIL

DESCRIPTION
COVER

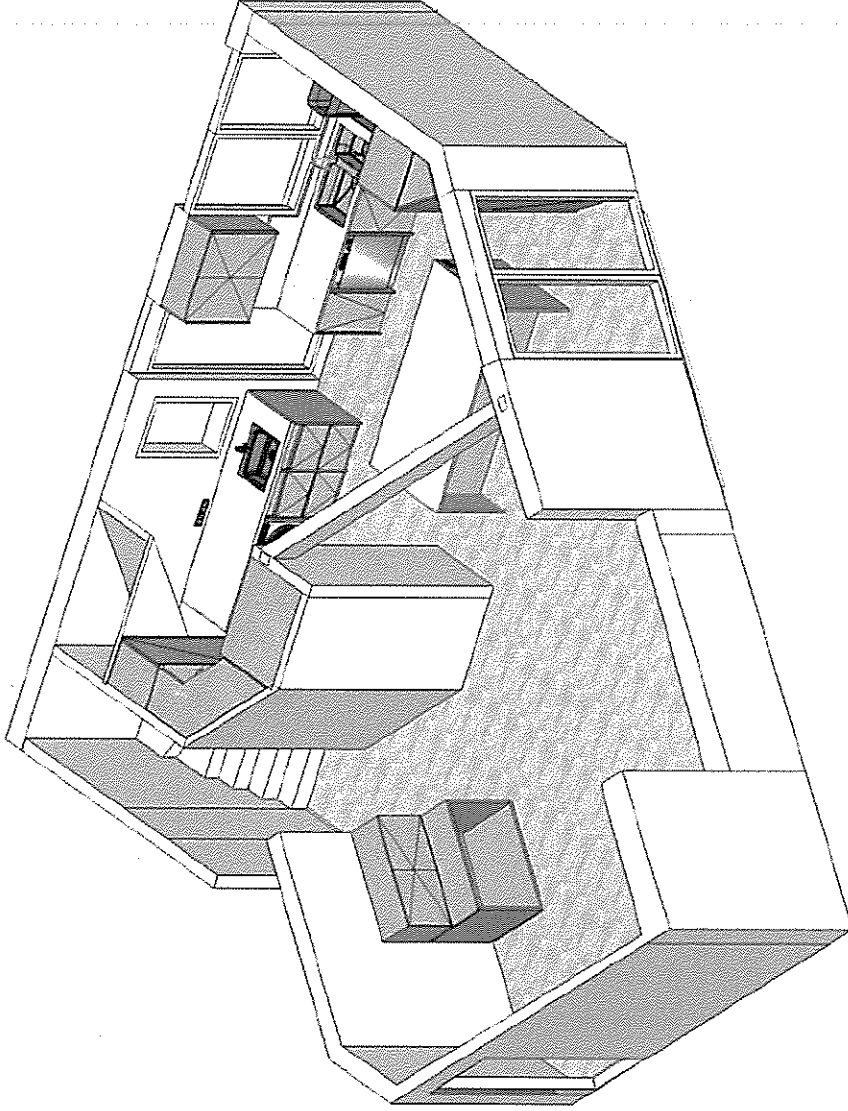

A 000

ALL COPYRIGHTS RESERVED. ALL DIMENSIONS ARE NOT TO BE
EXCEEDED OR EXCEEDED WITHOUT PRIOR PERMISSION
OF THE RESPECTIVE COMPANIES.

JOINERY #K2 AND K3

NOTE: ALLOW FOR 20MM VERTICAL SHADOW LINE. REFER TO JOINERY ELEVATIONS

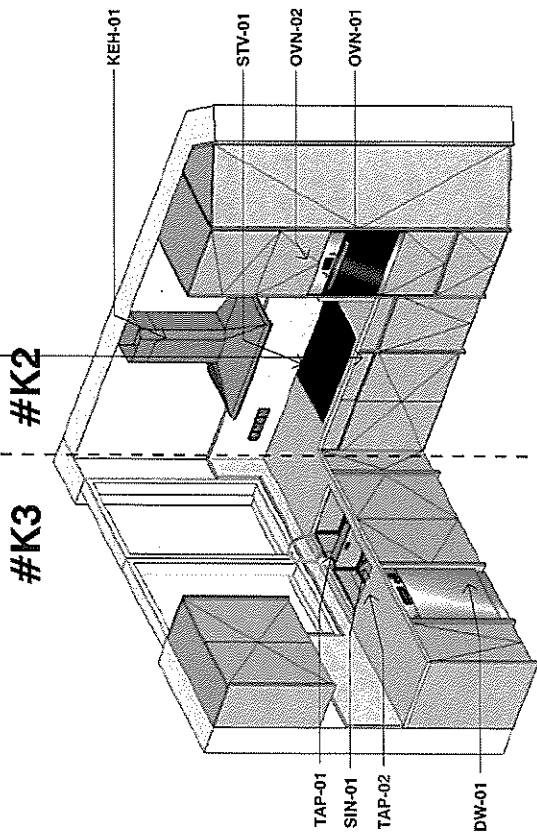

LEGEND

- TAP-01**
FRANKE ATLAS NEO TAP/TO
- TAP-02**
ZIP TAP OR SIMILAR (CLIENT TO CONFIRM)
- SIN-01**
FRANKE MYX220-50/3/4P/CSBR UNDERMOUNT SINK
- DW-01**
MIELE G7314 9CU AUTODOS CLIST BUILT UNDER DISHWASHER
- KEH-01**
SMEG SHW900XIN RANGEHOOD (DUCTED)
- STV-01**
SMEG SAEG38E3D 90CM INDUCTION AND GAS COOKTOP
- OVN-01**
NEFT N90 848FT78H00 STEAM OVEN
- OVN-02**
EXISTING MICROWAVE SUPPLIED BY CLIENT (KEEP MIN. 450MM CLEAR HEIGHT)
- LAM01**
LUMINEX RAW BIRCHPLY (NATURAL)
- ST01**
CEASARSTONE COSMOPOLITAN WHITE (20mm thk, polished)
- MELO1**
MOISTURE RESISTANT MELAMINE WHITE MATT TO ALL INTERVALS OF JOINERY

NOTE:

ALL DIMENSIONS ARE INDICATIVE ONLY. BUILDER IS TO DO FULL SITE MEASURE POST COMPLETION OF ALL STRUCTURAL WORKS AND TO CONSIDER ALL REQUIRED SERVICES AND

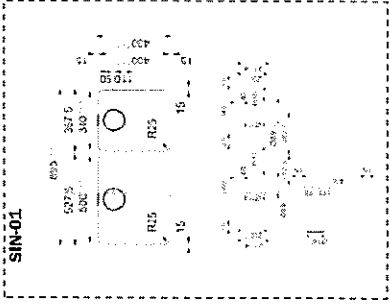

TYPICAL STONE EDGE DETAIL TO CUPBOARD

JOINERY HINGES AND FITTINGS:
SOFT CLOSING
BLUM OR HAFELE ONLY

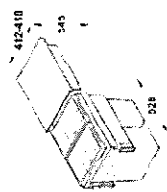
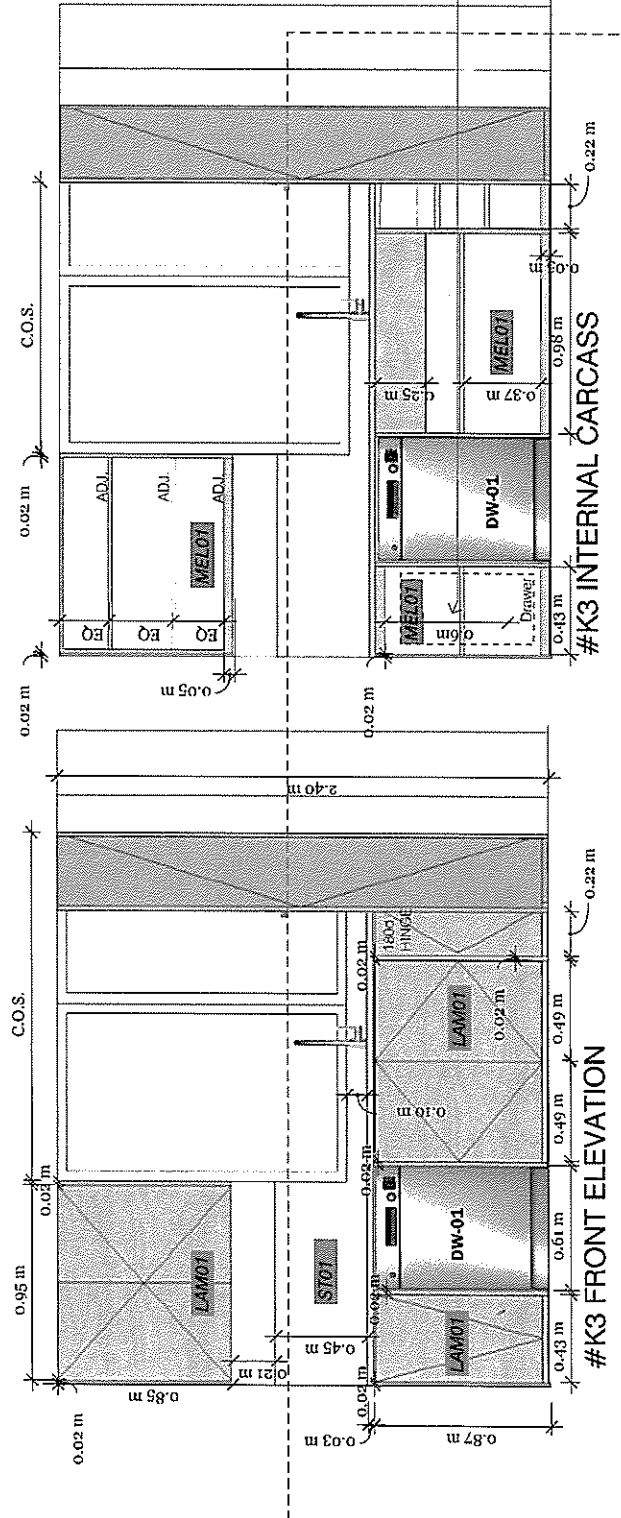

DRAWER TO INCLUDE Hafele Waste Bin (2 nos), Hafele Euro Cargo ST45 in white

IRWIN H.
DESIGN. INTERIOR

DESIGNED BY:
IRWIN
Melbourne, Australia
EMAIL:
irwin.ho.g@gmail.com

CLIENT
SHERMAN LOO & HO LEE SING
2/85 MANNINGHAM ST
PARKVILLE
VIC 3023

PROJECT
KITCHEN, PANTRY AND DINING
JOINERY

DRAWN BY
IH

ISSUE
18.04.2024(T0)
16.07.2024(T1)

REVISION
NIL

DESCRIPTION
JOINERY DRAWINGS
#K2

A 201

ALL DRAWINGS RESERVED. ALL DRAWINGS ARE NOT TO BE REPRODUCED OR FORWARDED WITHOUT PERMISSION OF THE ARCHITECT/DESIGNER.

JOINERY #P1 AND #P2

NOTE: ALLOW FOR 20MM VERTICAL SHADOW LINE. REFER TO JOINERY ELEVATIONS

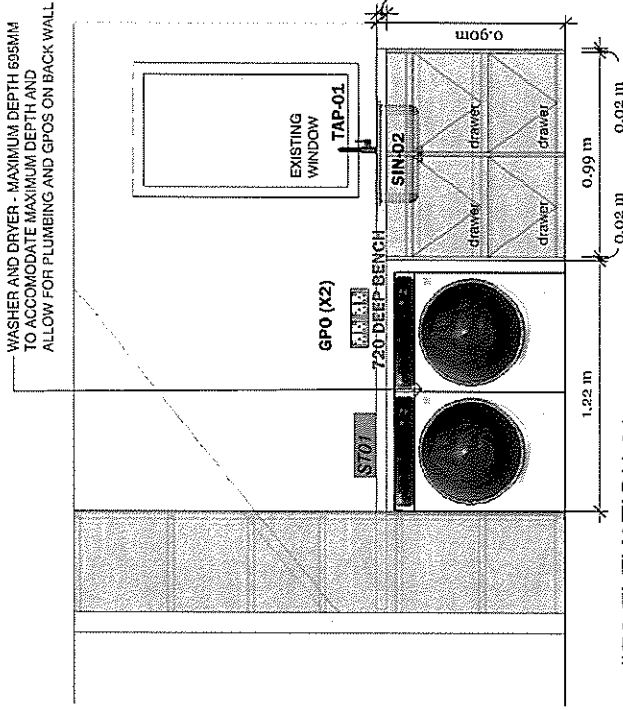
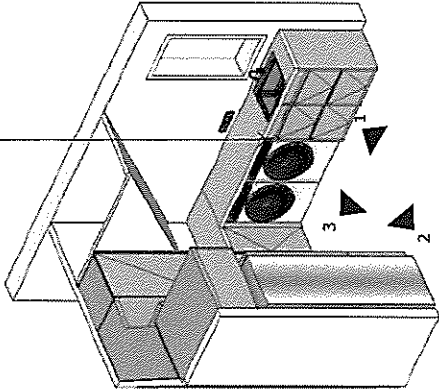

#P2 ELEVATION 01

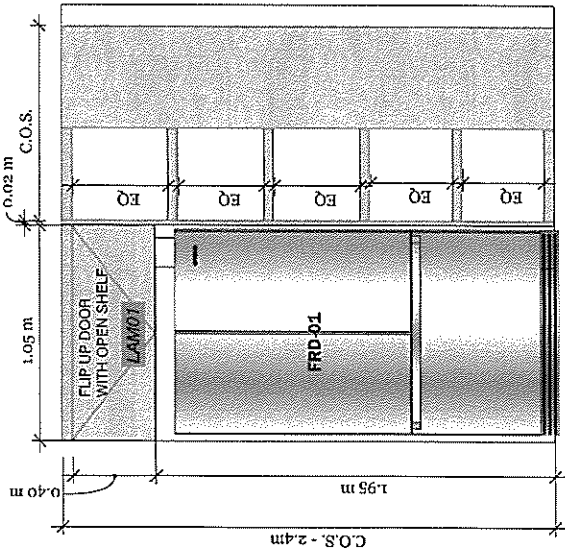

#P1 ELEVATION 02

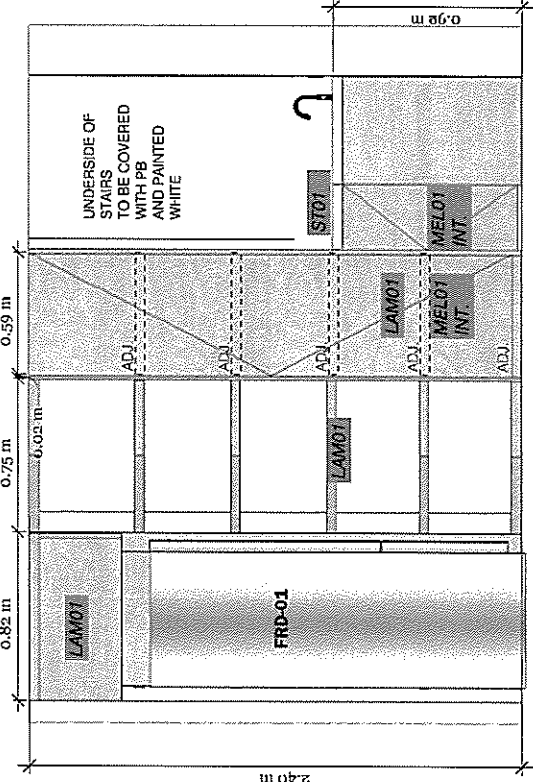

#P1 ELEVATION 03

C.O.S. WIDTH OF SWING DOOR TO ACCESS UNDERBENCH STORAGE

IRWIN H.
DESIGN. INTERIOR

TAP-02
ABI INTERIOR - Elysian Kitchen Mixer - Brushed Nickel

SIN-02
FRANKE DLT 610 TOPMOUNT SINK

FRD-01
Midea G9L French Door Inverter Fridge - Matte Glass White RWB540V7DXMGV

GPO
CLIPSAL SATURN ZEN DOUBLE GPO (WHITE)

LAM01
LAMINEX RAW BIRCHPLY (NATURAL)

ST01
CAESARSTONE COSMOPOLITAN WHITE (20mm thick, polished)

MELO1
MOISTURE RESISTANT MELAMINE WHITE MATT TO ALL INTERNALS OF JOINERY

LEGEND

NOTE:
ALL DIMENSIONS ARE INDICATIVE ONLY
BUILDER IS TO DO FULL SITE MEASURE POST CONSTRUCTION TO VERIFY JOINTS AND TO CONSIDER ALL REQUIRED SERVICES AND MATERIAL THICKNESS IE FLOOR FINISHES ETC.

CLIENT
SHERMAN LOO & HO LEE SING
2/85 MANNINGHAM ST
PARKVILLE
VIC 3023

PROJECT
KITCHEN, PANTRY AND DINING JOINERY

ISSUE
18.04.2024(TO)
16.07.2024(TL)

DESCRIPTION
JOINERY DRAWINGS
#P1 & P2

A 203

ALL COPYRIGHTS RESERVED. ALL DRAWINGS ARE ACT TO BE PREPARED OR PRODUCED WITHOUT THE PERMISSION OF THE RESPECTIVE COMPANY.

