

Master Bedroom

Cabinet: - 1.

+ = Hinges

* UPPER Door to have 15mm holes Set 50mm apart all the way thru. T.B.C

Cabinet 992w

2028 Finished Size

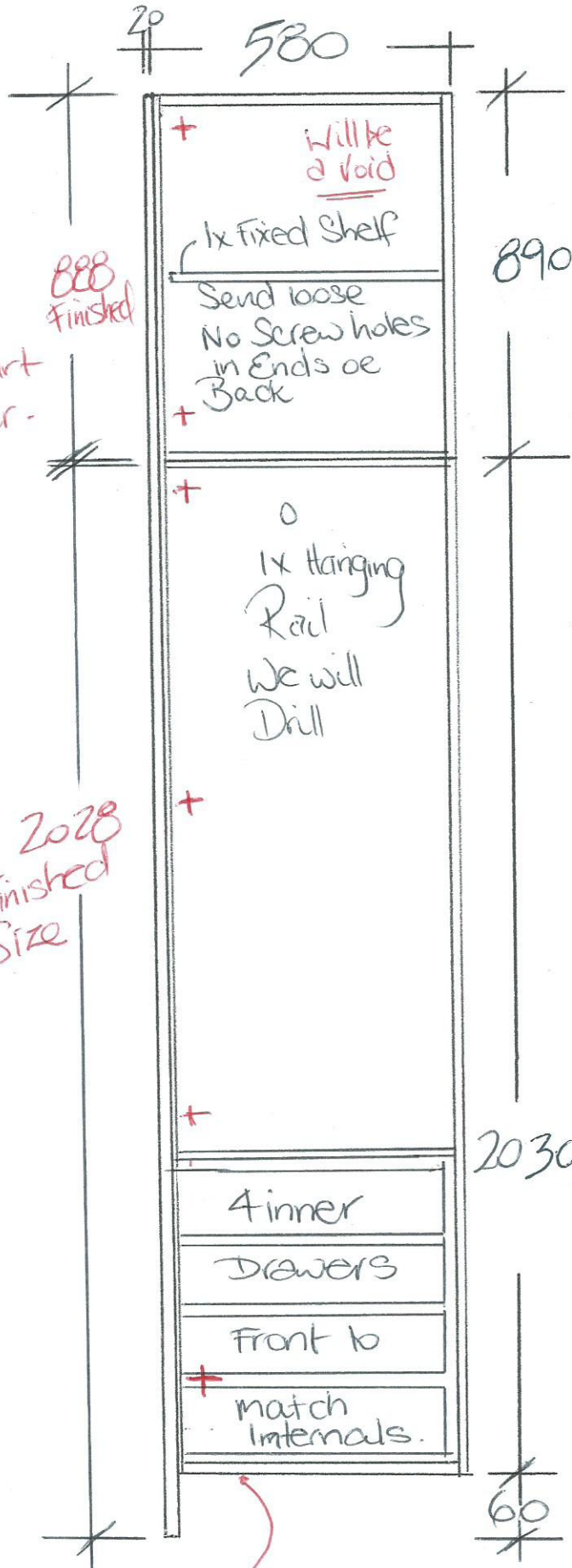

* Doors to be grain matched

* these doors will be NAVLAM Shinnok Pure Walnut Both Sides - Pressed on 16 Black Core MDF.

master Bedroom

Cabinet:- 3

+ = Hinges

* Doors to be grain matched

* these doors will be NAV LAM Shinnok Pure Walnut Both Sides - Pressed on

16 Black Core MDF

* UPPER Door to have 15mm holes Set 50mm apart all the way thru - T.B.C

Cabinet 992w

2028 Finished Size

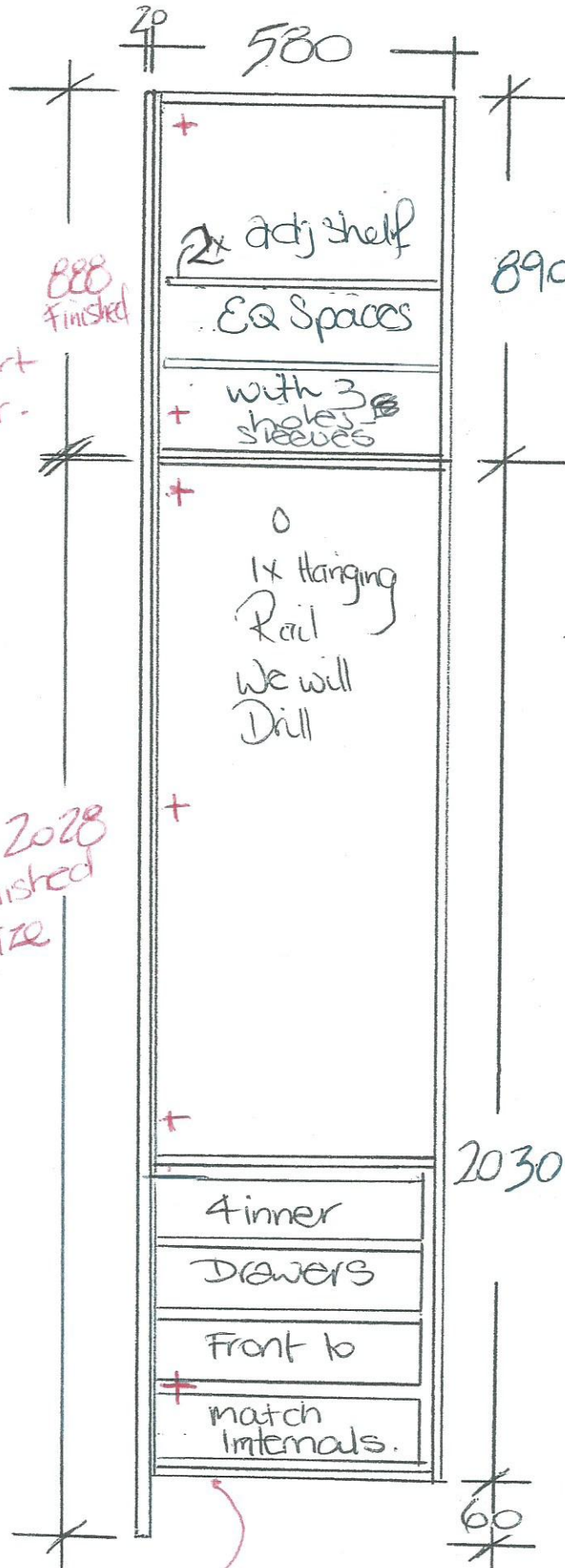

master Bedroom

Cabinet :- 2

* UPPER Door
hides
as per
Cabinet 1.

* This cabinet
will have a
Cut out in
Back

Cabinet
width
992W

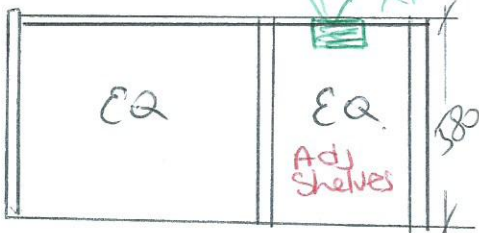

16 472 16 472 16
(PLAN VIEW ↑)

5 adj shelves

EQ Space.

Using Hafele

282.50.753
Sleeve

282.01.750 (8mm hole)

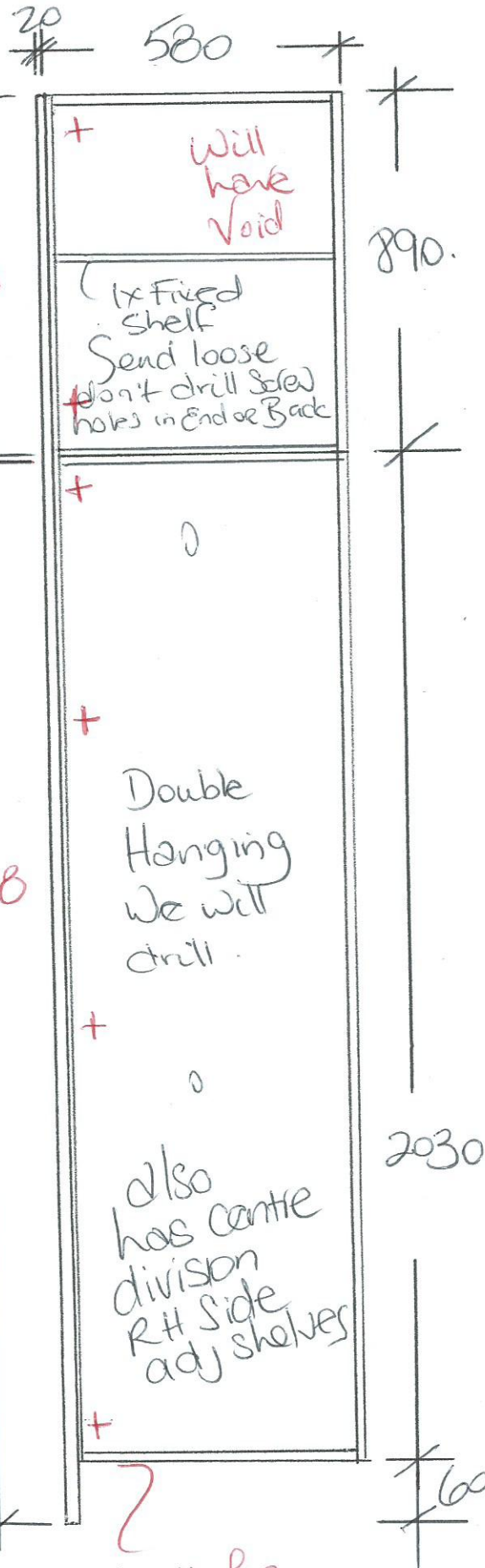

+ = Hinges
all same height

* All hinges
to Match
in heights.

* Grain
Matched
as cab 1
+ Black Core

Not Sure
where
yet

also
has centre
division
R+H side
adj shelves

Drill for
Legs please.

Adj

o 3holes

o 32mm
Apart

o

(3)

282.01.701

— or maybe 282.50.704. (7.5mm Hole)

master Bedroom

Cabinet: - 4.

Will need to look at heavy duty ones

(+) = Hinges all same heights Please

* Grain match

Normal NAU Both Sides MDF

See below 1165w Cabinet

2978h

Door Finished Size

No hole in upper- 1x Full height door

500

890

2030

60

Please drill for legs

(4)

No Edges 100w

Send loose - don't drill cabinet internal colour

door will extend past cabinet by 85mm

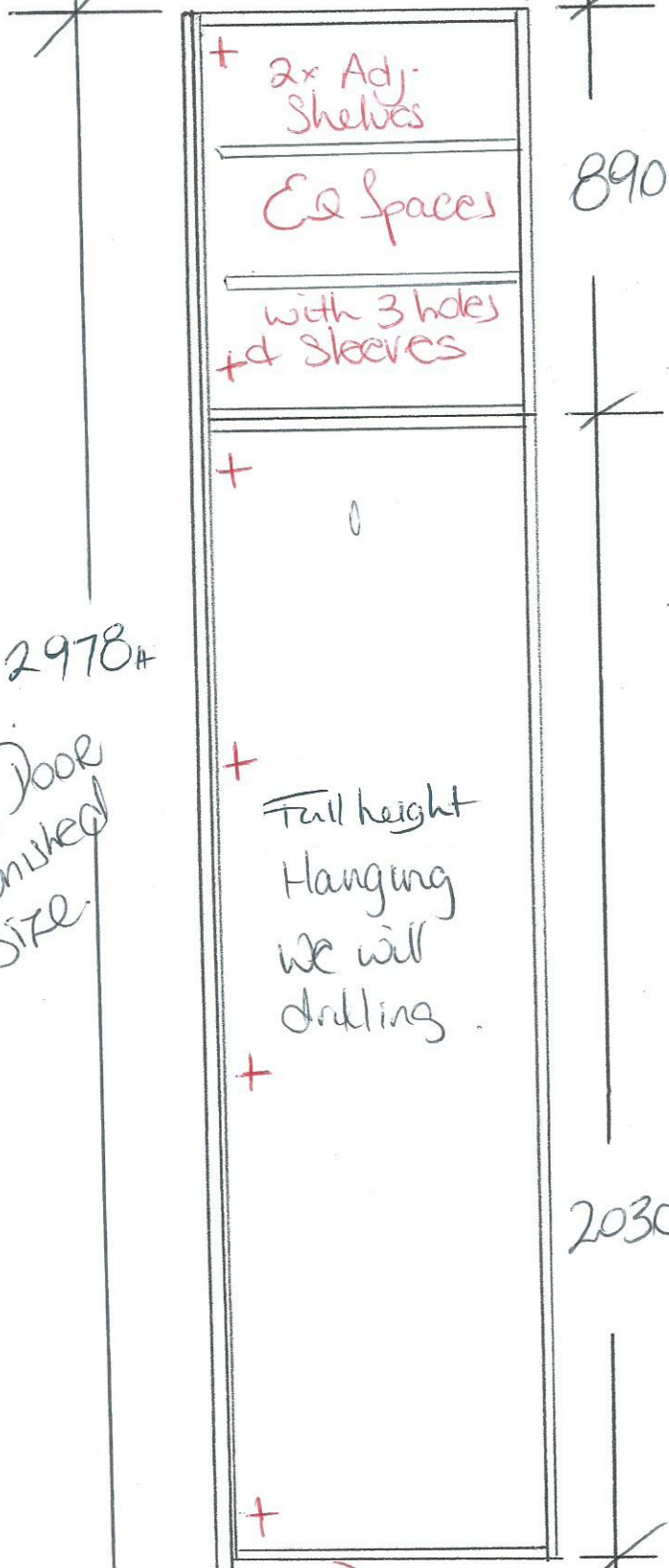
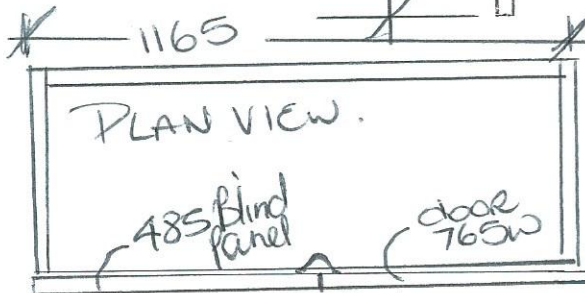

master Bedroom

Cabinet: - 5.
Will need to look at heavy duty hinges

(+) = Hinges

all same Heights please.

Grain Match

16. Normal Now.

t.b.a.

t.b.a.

765 Wide Cabinet

2978# Door Finished Size

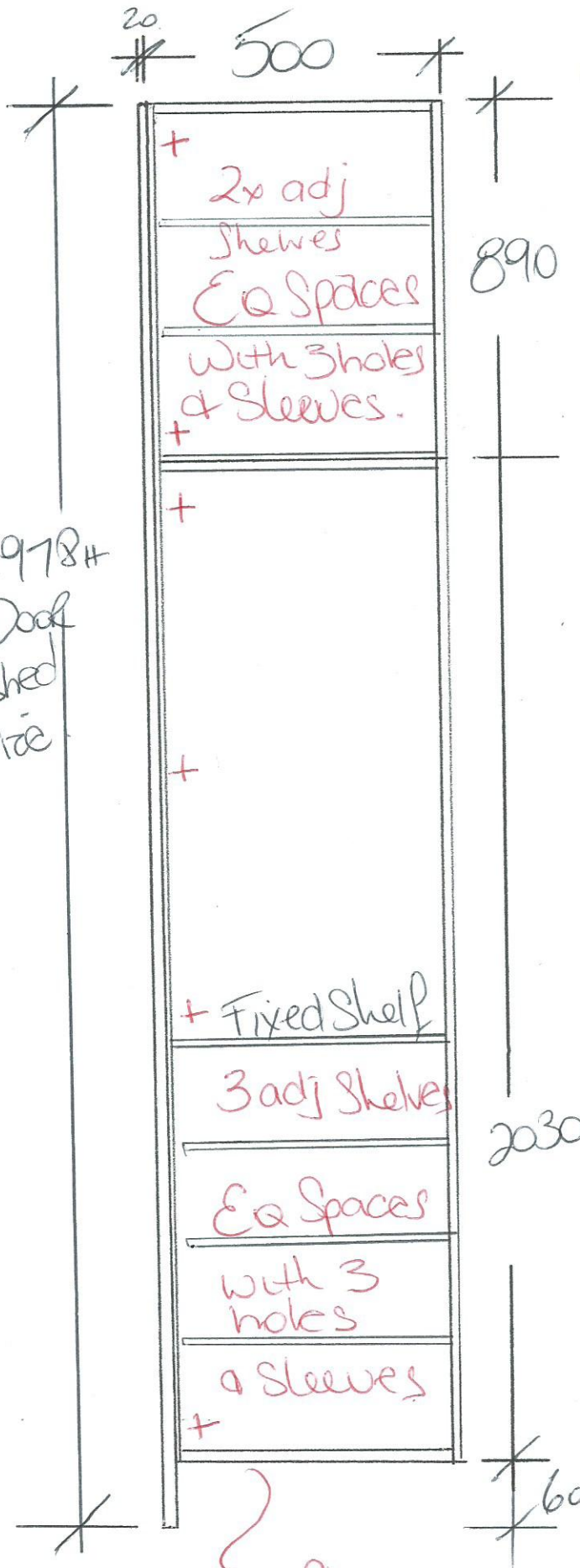

Please drill for legs

master Bedroom

detail 6:-
Bed side tables-

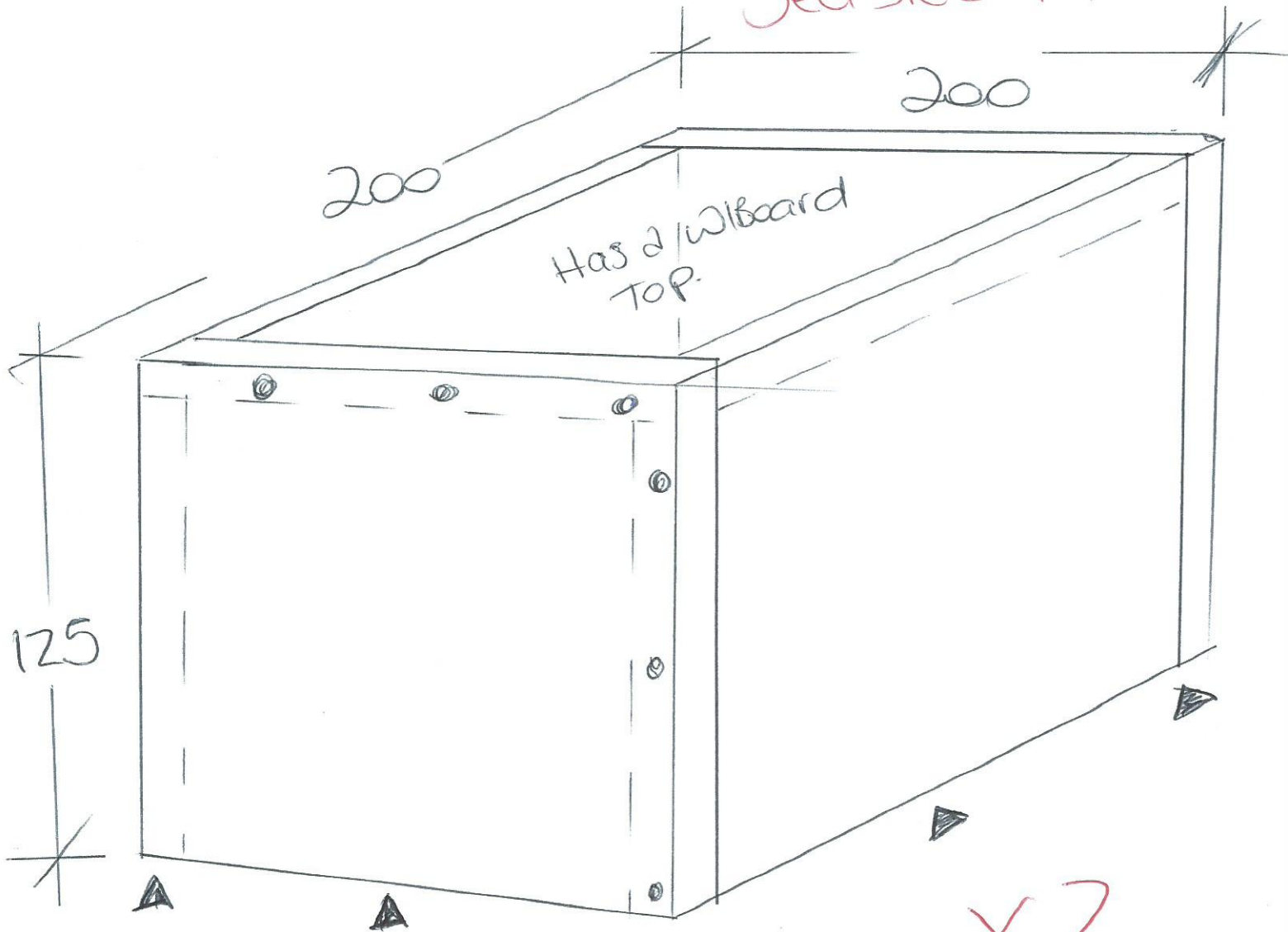

X2

↑ open on the Bottom.

* All
18mm
MDF

All bottom edge to be edge in
New lam - Shinnoki, pure Walnut.

* Please don't to Radius
Edge - I'm laminating in inside
& out -

(6)